

Network Working Group
Request for Comments: 4728
Category: Experimental

D. Johnson
Rice University
Y. Hu
UIUC
D. Maltz
Microsoft Research
February 2007

The Dynamic Source Routing Protocol (DSR)
for Mobile Ad Hoc Networks for IPv4

Status of This Memo

This memo defines an Experimental Protocol for the Internet community. It does not specify an Internet standard of any kind. Discussion and suggestions for improvement are requested. Distribution of this memo is unlimited.

Copyright Notice

Copyright (C) The IETF Trust (2007).

Abstract

The Dynamic Source Routing protocol (DSR) is a simple and efficient routing protocol designed specifically for use in multi-hop wireless ad hoc networks of mobile nodes. DSR allows the network to be completely self-organizing and self-configuring, without the need for any existing network infrastructure or administration. The protocol is composed of the two main mechanisms of "Route Discovery" and "Route Maintenance", which work together to allow nodes to discover and maintain routes to arbitrary destinations in the ad hoc network. All aspects of the protocol operate entirely on demand, allowing the routing packet overhead of DSR to scale automatically to only what is needed to react to changes in the routes currently in use. The protocol allows multiple routes to any destination and allows each sender to select and control the routes used in routing its packets, for example, for use in load balancing or for increased robustness. Other advantages of the DSR protocol include easily guaranteed loop-free routing, operation in networks containing unidirectional links, use of only "soft state" in routing, and very rapid recovery when routes in the network change. The DSR protocol is designed mainly for mobile ad hoc networks of up to about two hundred nodes and is designed to work well even with very high rates of mobility. This document specifies the operation of the DSR protocol for routing unicast IPv4 packets.

Table of Contents

1. Introduction	5
2. Assumptions	7
3. DSR Protocol Overview	9
3.1. Basic DSR Route Discovery	10
3.2. Basic DSR Route Maintenance	12
3.3. Additional Route Discovery Features	14
3.3.1. Caching Overheard Routing Information	14
3.3.2. Replying to Route Requests Using Cached Routes	15
3.3.3. Route Request Hop Limits	16
3.4. Additional Route Maintenance Features	17
3.4.1. Packet Salvaging	17
3.4.2. Queued Packets Destined over a Broken Link	18
3.4.3. Automatic Route Shortening	19
3.4.4. Increased Spreading of Route Error Messages	20
3.5. Optional DSR Flow State Extension	20
3.5.1. Flow Establishment	21
3.5.2. Receiving and Forwarding Establishment Packets	22
3.5.3. Sending Packets along Established Flows	22
3.5.4. Receiving and Forwarding Packets Sent along Established Flows	23
3.5.5. Processing Route Errors	24
3.5.6. Interaction with Automatic Route Shortening	24
3.5.7. Loop Detection	25
3.5.8. Acknowledgement Destination	25
3.5.9. Crash Recovery	25
3.5.10. Rate Limiting	25
3.5.11. Interaction with Packet Salvaging	26
4. Conceptual Data Structures	26
4.1. Route Cache	26
4.2. Send Buffer	30
4.3. Route Request Table	30
4.4. Gratuitous Route Reply Table	31
4.5. Network Interface Queue and Maintenance Buffer	32
4.6. Blacklist	33
5. Additional Conceptual Data Structures for Flow State Extension	34
5.1. Flow Table	34
5.2. Automatic Route Shortening Table	35
5.3. Default Flow ID Table	36
6. DSR Options Header Format	36
6.1. Fixed Portion of DSR Options Header	37
6.2. Route Request Option	40
6.3. Route Reply Option	42

6.4.	Route Error Option	44
6.4.1.	Node Unreachable Type-Specific Information	46
6.4.2.	Flow State Not Supported Type-Specific Information	46
6.4.3.	Option Not Supported Type-Specific Information	46
6.5.	Acknowledgement Request Option	46
6.6.	Acknowledgement Option	47
6.7.	DSR Source Route Option	48
6.8.	Pad1 Option	50
6.9.	PadN Option	50
7.	Additional Header Formats and Options for Flow State Extension	51
7.1.	DSR Flow State Header	52
7.2.	New Options and Extensions in DSR Options Header	52
7.2.1.	Timeout Option	52
7.2.2.	Destination and Flow ID Option	53
7.3.	New Error Types for Route Error Option	54
7.3.1.	Unknown Flow Type-Specific Information	54
7.3.2.	Default Flow Unknown Type-Specific Information	55
7.4.	New Acknowledgement Request Option Extension	55
7.4.1.	Previous Hop Address Extension	55
8.	Detailed Operation	56
8.1.	General Packet Processing	56
8.1.1.	Originating a Packet	56
8.1.2.	Adding a DSR Options Header to a Packet	57
8.1.3.	Adding a DSR Source Route Option to a Packet	57
8.1.4.	Processing a Received Packet	58
8.1.5.	Processing a Received DSR Source Route Option	60
8.1.6.	Handling an Unknown DSR Option	63
8.2.	Route Discovery Processing	64
8.2.1.	Originating a Route Request	65
8.2.2.	Processing a Received Route Request Option	66
8.2.3.	Generating a Route Reply Using the Route Cache	68
8.2.4.	Originating a Route Reply	71
8.2.5.	Preventing Route Reply Storms	72
8.2.6.	Processing a Received Route Reply Option	74
8.3.	Route Maintenance Processing	74
8.3.1.	Using Link-Layer Acknowledgements	75
8.3.2.	Using Passive Acknowledgements	76
8.3.3.	Using Network-Layer Acknowledgements	77
8.3.4.	Originating a Route Error	80
8.3.5.	Processing a Received Route Error Option	81
8.3.6.	Salvaging a Packet	82
8.4.	Multiple Network Interface Support	84
8.5.	IP Fragmentation and Reassembly	84
8.6.	Flow State Processing	85
8.6.1.	Originating a Packet	85
8.6.2.	Inserting a DSR Flow State Header	88

8.6.3. Receiving a Packet88

8.6.4. Forwarding a Packet Using Flow IDs93

8.6.5. Promiscuously Receiving a Packet93

8.6.6. Operation Where the Layer below DSR
Decreases the IP TTL94

8.6.7. Salvage Interactions with DSR94

9. Protocol Constants and Configuration Variables95

10. IANA Considerations96

11. Security Considerations96

Appendix A. Link-MaxLife Cache Description97

Appendix B. Location of DSR in the ISO Network Reference Model99

Appendix C. Implementation and Evaluation Status100

Acknowledgements101

Normative References102

Informative References102

1. Introduction

The Dynamic Source Routing protocol (DSR) [JOHNSON94, JOHNSON96a] is a simple and efficient routing protocol designed specifically for use in multi-hop wireless ad hoc networks of mobile nodes. Using DSR, the network is completely self-organizing and self-configuring, requiring no existing network infrastructure or administration. Network nodes cooperate to forward packets for each other to allow communication over multiple "hops" between nodes not directly within wireless transmission range of one another. As nodes in the network move about or join or leave the network, and as wireless transmission conditions such as sources of interference change, all routing is automatically determined and maintained by the DSR routing protocol. Since the number or sequence of intermediate hops needed to reach any destination may change at any time, the resulting network topology may be quite rich and rapidly changing.

In designing DSR, we sought to create a routing protocol that had very low overhead yet was able to react very quickly to changes in the network. The DSR protocol provides highly reactive service in order to help ensure successful delivery of data packets in spite of node movement or other changes in network conditions.

The DSR protocol is composed of two main mechanisms that work together to allow the discovery and maintenance of source routes in the ad hoc network:

- Route Discovery is the mechanism by which a node S wishing to send a packet to a destination node D obtains a source route to D. Route Discovery is used only when S attempts to send a packet to D and does not already know a route to D.
- Route Maintenance is the mechanism by which node S is able to detect, while using a source route to D, if the network topology has changed such that it can no longer use its route to D because a link along the route no longer works. When Route Maintenance indicates a source route is broken, S can attempt to use any other route it happens to know to D, or it can invoke Route Discovery again to find a new route for subsequent packets to D. Route Maintenance for this route is used only when S is actually sending packets to D.

In DSR, Route Discovery and Route Maintenance each operate entirely "on demand". In particular, unlike other protocols, DSR requires no periodic packets of any kind at any layer within the network. For example, DSR does not use any periodic routing advertisement, link status sensing, or neighbor detection packets and does not rely on these functions from any underlying protocols in the network. This

entirely on-demand behavior and lack of periodic activity allows the number of overhead packets caused by DSR to scale all the way down to zero, when all nodes are approximately stationary with respect to each other and all routes needed for current communication have already been discovered. As nodes begin to move more or as communication patterns change, the routing packet overhead of DSR automatically scales to only what is needed to track the routes currently in use. Network topology changes not affecting routes currently in use are ignored and do not cause reaction from the protocol.

All state maintained by DSR is "soft state" [CLARK88], in that the loss of any state will not interfere with the correct operation of the protocol; all state is discovered as needed and can easily and quickly be rediscovered if needed after a failure without significant impact on the protocol. This use of only soft state allows the routing protocol to be very robust to problems such as dropped or delayed routing packets or node failures. In particular, a node in DSR that fails and reboots can easily rejoin the network immediately after rebooting; if the failed node was involved in forwarding packets for other nodes as an intermediate hop along one or more routes, it can also resume this forwarding quickly after rebooting, with no or minimal interruption to the routing protocol.

In response to a single Route Discovery (as well as through routing information from other packets overheard), a node may learn and cache multiple routes to any destination. This support for multiple routes allows the reaction to routing changes to be much more rapid, since a node with multiple routes to a destination can try another cached route if the one it has been using should fail. This caching of multiple routes also avoids the overhead of needing to perform a new Route Discovery each time a route in use breaks. The sender of a packet selects and controls the route used for its own packets, which, together with support for multiple routes, also allows features such as load balancing to be defined. In addition, all routes used are easily guaranteed to be loop-free, since the sender can avoid duplicate hops in the routes selected.

The operation of both Route Discovery and Route Maintenance in DSR are designed to allow unidirectional links and asymmetric routes to be supported. In particular, as noted in Section 2, in wireless networks, it is possible that a link between two nodes may not work equally well in both directions, due to differing transmit power levels or sources of interference.

It is possible to interface a DSR network with other networks, external to this DSR network. Such external networks may, for example, be the Internet or may be other ad hoc networks routed with

a routing protocol other than DSR. Such external networks may also be other DSR networks that are treated as external networks in order to improve scalability. The complete handling of such external networks is beyond the scope of this document. However, this document specifies a minimal set of requirements and features necessary to allow nodes only implementing this specification to interoperate correctly with nodes implementing interfaces to such external networks.

This document specifies the operation of the DSR protocol for routing unicast IPv4 packets in multi-hop wireless ad hoc networks. Advanced, optional features, such as Quality of Service (QoS) support and efficient multicast routing, and operation of DSR with IPv6 [RFC2460], will be covered in other documents. The specification of DSR in this document provides a compatible base on which such features can be added, either independently or by integration with the DSR operation specified here. As described in Appendix C, the design of DSR has been extensively studied through detailed simulations and testbed implementation and demonstration; this document encourages additional implementation and experimentation with the protocol.

The keywords "MUST", "MUST NOT", "REQUIRED", "SHALL", "SHALL NOT", "SHOULD", "SHOULD NOT", "RECOMMENDED", "MAY", and "OPTIONAL" in this document are to be interpreted as described in RFC 2119 [RFC2119].

2. Assumptions

As described here, the DSR protocol is designed mainly for mobile ad hoc networks of up to about two hundred nodes and is designed to work well even with very high rates of mobility. Other protocol features and enhancements that may allow DSR to scale to larger networks are outside the scope of this document.

We assume in this document that all nodes wishing to communicate with other nodes within the ad hoc network are willing to participate fully in the protocols of the network. In particular, each node participating in the ad hoc network SHOULD also be willing to forward packets for other nodes in the network.

The diameter of an ad hoc network is the minimum number of hops necessary for a packet to reach from any node located at one extreme edge of the ad hoc network to another node located at the opposite extreme. We assume that this diameter will often be small (e.g., perhaps 5 or 10 hops), but it may often be greater than 1.

Packets may be lost or corrupted in transmission on the wireless network. We assume that a node receiving a corrupted packet can detect the error, such as through a standard link-layer checksum or Cyclic Redundancy Check (CRC), and discard the packet.

Nodes within the ad hoc network MAY move at any time without notice and MAY even move continuously, but we assume that the speed with which nodes move is moderate with respect to the packet transmission latency and wireless transmission range of the particular underlying network hardware in use. In particular, DSR can support very rapid rates of arbitrary node mobility, but we assume that nodes do not continuously move so rapidly as to make the flooding of every individual data packet the only possible routing protocol.

A common feature of many network interfaces, including most current LAN hardware for broadcast media such as wireless, is the ability to operate the network interface in "promiscuous" receive mode. This mode causes the hardware to deliver every received packet to the network driver software without filtering based on link-layer destination address. Although we do not require this facility, some of our optimizations can take advantage of its availability. Use of promiscuous mode does increase the software overhead on the CPU, but we believe that wireless network speeds and capacity are more the inherent limiting factors to performance in current and future systems; we also believe that portions of the protocol are suitable for implementation directly within a programmable network interface unit to avoid this overhead on the CPU [JOHNSON96a]. Use of promiscuous mode may also increase the power consumption of the network interface hardware, depending on the design of the receiver hardware, and in such cases, DSR can easily be used without the optimizations that depend on promiscuous receive mode or can be programmed to only periodically switch the interface into promiscuous mode. Use of promiscuous receive mode is entirely optional.

Wireless communication ability between any pair of nodes may at times not work equally well in both directions, due, for example, to transmit power levels or sources of interference around the two nodes [BANTZ94, LAUER95]. That is, wireless communications between each pair of nodes will in many cases be able to operate bidirectionally, but at times the wireless link between two nodes may be only unidirectional, allowing one node to successfully send packets to the other while no communication is possible in the reverse direction. Some Medium Access Control (MAC) protocols, however, such as MACA [KARN90], MACAW [BHARGHAVAN94], or IEEE 802.11 [IEEE80211], limit unicast data packet transmission to bidirectional links, due to the required bidirectional exchange of request to send (RTS) and clear to send (CTS) packets in these protocols and to the link-layer acknowledgement feature in IEEE 802.11. When used on top of MAC

protocols such as these, DSR can take advantage of additional optimizations, such as the ability to reverse a source route to obtain a route back to the origin of the original route.

The IP address used by a node using the DSR protocol MAY be assigned by any mechanism (e.g., static assignment or use of Dynamic Host Configuration Protocol (DHCP) for dynamic assignment [RFC2131]), although the method of such assignment is outside the scope of this specification.

A routing protocol such as DSR chooses a next-hop for each packet and provides the IP address of that next-hop. When the packet is transmitted, however, the lower-layer protocol often has a separate, MAC-layer address for the next-hop node. DSR uses the Address Resolution Protocol (ARP) [RFC826] to translate from next-hop IP addresses to next-hop MAC addresses. In addition, a node MAY add an entry to its ARP cache based on any received packet, when the IP address and MAC address of the transmitting node are available in the packet; for example, the IP address of the transmitting node is present in a Route Request option (in the Address list being accumulated) and any packets containing a source route. Adding entries to the ARP cache in this way avoids the overhead of ARP in most cases.

3. DSR Protocol Overview

This section provides an overview of the operation of the DSR protocol. The basic version of DSR uses explicit "source routing", in which each data packet sent carries in its header the complete, ordered list of nodes through which the packet will pass. This use of explicit source routing allows the sender to select and control the routes used for its own packets, supports the use of multiple routes to any destination (for example, for load balancing), and allows a simple guarantee that the routes used are loop-free. By including this source route in the header of each data packet, other nodes forwarding or overhearing any of these packets can also easily cache this routing information for future use. Section 3.1 describes this basic operation of Route Discovery, Section 3.2 describes basic Route Maintenance, and Sections 3.3 and 3.4 describe additional features of these two parts of DSR's operation. Section 3.5 then describes an optional, compatible extension to DSR, known as "flow state", that allows the routing of most packets without an explicit source route header in the packet, while the fundamental properties of DSR's operation are preserved.

3.1. Basic DSR Route Discovery

When some source node originates a new packet addressed to some destination node, the source node places in the header of the packet a "source route" giving the sequence of hops that the packet is to follow on its way to the destination. Normally, the sender will obtain a suitable source route by searching its "Route Cache" of routes previously learned; if no route is found in its cache, it will initiate the Route Discovery protocol to dynamically find a new route to this destination node. In this case, we call the source node the "initiator" and the destination node the "target" of the Route Discovery.

For example, suppose a node A is attempting to discover a route to node E. The Route Discovery initiated by node A in this example would proceed as follows:

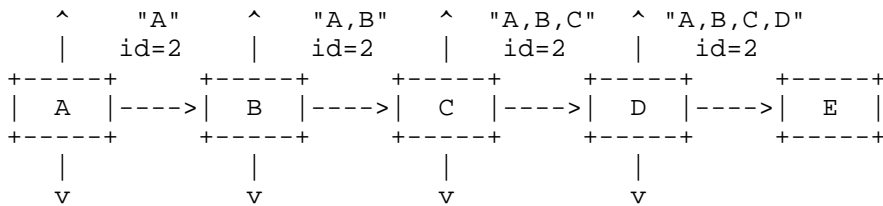

To initiate the Route Discovery, node A transmits a "Route Request" as a single local broadcast packet, which is received by (approximately) all nodes currently within wireless transmission range of A, including node B in this example. Each Route Request identifies the initiator and target of the Route Discovery, and also contains a unique request identification (2, in this example), determined by the initiator of the Request. Each Route Request also contains a record listing the address of each intermediate node through which this particular copy of the Route Request has been forwarded. This route record is initialized to an empty list by the initiator of the Route Discovery. In this example, the route record initially lists only node A.

When another node receives this Route Request (such as node B in this example), if it is the target of the Route Discovery, it returns a "Route Reply" to the initiator of the Route Discovery, giving a copy of the accumulated route record from the Route Request; when the initiator receives this Route Reply, it caches this route in its Route Cache for use in sending subsequent packets to this destination.

Otherwise, if this node receiving the Route Request has recently seen another Route Request message from this initiator bearing this same request identification and target address, or if this node's own address is already listed in the route record in the Route Request, this node discards the Request. (A node considers a Request recently seen if it still has information about that Request in its Route Request Table, which is described in Section 4.3.) Otherwise, this node appends its own address to the route record in the Route Request and propagates it by transmitting it as a local broadcast packet (with the same request identification). In this example, node B broadcast the Route Request, which is received by node C; nodes C and D each also, in turn, broadcast the Request, resulting in receipt of a copy of the Request by node E.

In returning the Route Reply to the initiator of the Route Discovery, such as in this example, node E replying back to node A, node E will typically examine its own Route Cache for a route back to A and, if one is found, will use it for the source route for delivery of the packet containing the Route Reply. Otherwise, E SHOULD perform its own Route Discovery for target node A, but to avoid possible infinite recursion of Route Discoveries, it MUST in this case piggyback this Route Reply on the packet containing its own Route Request for A. It is also possible to piggyback other small data packets, such as a TCP SYN packet [RFC793], on a Route Request using this same mechanism.

Node E could instead simply reverse the sequence of hops in the route record that it is trying to send in the Route Reply and use this as the source route on the packet carrying the Route Reply itself. For MAC protocols, such as IEEE 802.11, that require a bidirectional frame exchange for unicast packets as part of the MAC protocol [IEEE80211], the discovered source route MUST be reversed in this way to return the Route Reply, since this route reversal tests the discovered route to ensure that it is bidirectional before the Route Discovery initiator begins using the route. This route reversal also avoids the overhead of a possible second Route Discovery.

When initiating a Route Discovery, the sending node saves a copy of the original packet (that triggered the discovery) in a local buffer called the "Send Buffer". The Send Buffer contains a copy of each packet that cannot be transmitted by this node because it does not yet have a source route to the packet's destination. Each packet in the Send Buffer is logically associated with the time that it was placed into the Send Buffer and is discarded after residing in the Send Buffer for some timeout period `SendBufferTimeout`; if necessary for preventing the Send Buffer from overflowing, a FIFO or other replacement strategy MAY also be used to evict packets even before they expire.

While a packet remains in the Send Buffer, the node SHOULD occasionally initiate a new Route Discovery for the packet's destination address. However, the node MUST limit the rate at which such new Route Discoveries for the same address are initiated (as described in Section 4.3), since it is possible that the destination node is not currently reachable. In particular, due to the limited wireless transmission range and the movement of the nodes in the network, the network may at times become partitioned, meaning that there is currently no sequence of nodes through which a packet could be forwarded to reach the destination. Depending on the movement pattern and the density of nodes in the network, such network partitions may be rare or common.

If a new Route Discovery was initiated for each packet sent by a node in such a partitioned network, a large number of unproductive Route Request packets would be propagated throughout the subset of the ad hoc network reachable from this node. In order to reduce the overhead from such Route Discoveries, a node SHOULD use an exponential back-off algorithm to limit the rate at which it initiates new Route Discoveries for the same target, doubling the timeout between each successive discovery initiated for the same target. If the node attempts to send additional data packets to this same destination node more frequently than this limit, the subsequent packets SHOULD be buffered in the Send Buffer until a Route Reply is received giving a route to this destination, but the node MUST NOT initiate a new Route Discovery until the minimum allowable interval between new Route Discoveries for this target has been reached. This limitation on the maximum rate of Route Discoveries for the same target is similar to the mechanism required by Internet nodes to limit the rate at which ARP Requests are sent for any single target IP address [RFC1122].

3.2. Basic DSR Route Maintenance

When originating or forwarding a packet using a source route, each node transmitting the packet is responsible for confirming that data can flow over the link from that node to the next hop. For example, in the situation shown below, node A has originated a packet for node E using a source route through intermediate nodes B, C, and D:

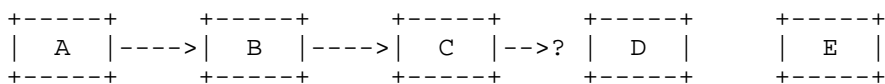

In this case, node A is responsible for the link from A to B, node B is responsible for the link from B to C, node C is responsible for the link from C to D, and node D is responsible for the link from D to E.

An acknowledgement can provide confirmation that a link is capable of carrying data, and in wireless networks, acknowledgements are often provided at no cost, either as an existing standard part of the MAC protocol in use (such as the link-layer acknowledgement frame defined by IEEE 802.11 [IEEE80211]), or by a "passive acknowledgement" [JUBIN87] (in which, for example, B confirms receipt at C by overhearing C transmit the packet when forwarding it on to D).

If a built-in acknowledgement mechanism is not available, the node transmitting the packet can explicitly request that a DSR-specific software acknowledgement be returned by the next node along the route; this software acknowledgement will normally be transmitted directly to the sending node, but if the link between these two nodes is unidirectional (Section 4.6), this software acknowledgement could travel over a different, multi-hop path.

After an acknowledgement has been received from some neighbor, a node MAY choose not to require acknowledgements from that neighbor for a brief period of time, unless the network interface connecting a node to that neighbor always receives an acknowledgement in response to unicast traffic.

When a software acknowledgement is used, the acknowledgement request SHOULD be retransmitted up to a maximum number of times. A retransmission of the acknowledgement request can be sent as a separate packet, piggybacked on a retransmission of the original data packet, or piggybacked on any packet with the same next-hop destination that does not also contain a software acknowledgement.

After the acknowledgement request has been retransmitted the maximum number of times, if no acknowledgement has been received, then the sender treats the link to this next-hop destination as currently "broken". It SHOULD remove this link from its Route Cache and SHOULD return a "Route Error" to each node that has sent a packet routed over that link since an acknowledgement was last received. For example, in the situation shown above, if C does not receive an acknowledgement from D after some number of requests, it would return a Route Error to A, as well as any other node that may have used the link from C to D since C last received an acknowledgement from D. Node A then removes this broken link from its cache; any retransmission of the original packet can be performed by upper layer protocols such as TCP, if necessary. For sending such a retransmission or other packets to this same destination E, if A has in its Route Cache another route to E (for example, from additional Route Replies from its earlier Route Discovery, or from having overheard sufficient routing information from other packets), it can

send the packet using the new route immediately. Otherwise, it SHOULD perform a new Route Discovery for this target (subject to the back-off described in Section 3.1).

3.3. Additional Route Discovery Features

3.3.1. Caching Overheard Routing Information

A node forwarding or otherwise overhearing any packet SHOULD add all usable routing information from that packet to its own Route Cache. The usefulness of routing information in a packet depends on the directionality characteristics of the physical medium (Section 2), as well as on the MAC protocol being used. Specifically, three distinct cases are possible:

- Links in the network frequently are capable of operating only unidirectionally (not bidirectionally), and the MAC protocol in use in the network is capable of transmitting unicast packets over unidirectional links.
- Links in the network occasionally are capable of operating only unidirectionally (not bidirectionally), but this unidirectional restriction on any link is not persistent; almost all links are physically bidirectional, and the MAC protocol in use in the network is capable of transmitting unicast packets over unidirectional links.
- The MAC protocol in use in the network is not capable of transmitting unicast packets over unidirectional links; only bidirectional links can be used by the MAC protocol for transmitting unicast packets. For example, the IEEE 802.11 Distributed Coordination Function (DCF) MAC protocol [IEEE80211] is capable of transmitting a unicast packet only over a bidirectional link, since the MAC protocol requires the return of a link-level acknowledgement packet from the receiver and also optionally requires the bidirectional exchange of an RTS and CTS packet between the transmitter and receiver nodes.

In the first case above, for example, the source route used in a data packet, the accumulated route record in a Route Request, or the route being returned in a Route Reply SHOULD all be cached by any node in the "forward" direction. Any node SHOULD cache this information from any such packet received, whether the packet was addressed to this node, sent to a broadcast (or multicast) MAC address, or overheard while the node's network interface is in promiscuous mode. However, the "reverse" direction of the links identified in such packet headers SHOULD NOT be cached.

For example, in the situation shown below, node A is using a source route to communicate with node E:

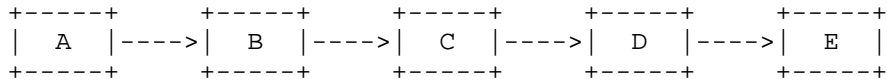

As node C forwards a data packet along the route from A to E, it SHOULD add to its cache the presence of the "forward" direction links that it learns from the headers of these packets, from itself to D and from D to E. Node C SHOULD NOT, in this case, cache the "reverse" direction of the links identified in these packet headers, from itself back to B and from B to A, since these links might be unidirectional.

In the second case above, in which links may occasionally operate unidirectionally, the links described above SHOULD be cached in both directions. Furthermore, in this case, if node X overhears (e.g., through promiscuous mode) a packet transmitted by node C that is using a source route from node A to E, node X SHOULD cache all of these links as well, also including the link from C to X over which it overheard the packet.

In the final case, in which the MAC protocol requires physical bidirectionality for unicast operation, links from a source route SHOULD be cached in both directions, except when the packet also contains a Route Reply, in which case only the links already traversed in this source route SHOULD be cached. However, the links not yet traversed in this route SHOULD NOT be cached.

3.3.2. Replying to Route Requests Using Cached Routes

A node receiving a Route Request for which it is not the target searches its own Route Cache for a route to the target of the Request. If it is found, the node generally returns a Route Reply to the initiator itself rather than forward the Route Request. In the Route Reply, this node sets the route record to list the sequence of hops over which this copy of the Route Request was forwarded to it, concatenated with the source route to this target obtained from its own Route Cache.

However, before transmitting a Route Reply packet that was generated using information from its Route Cache in this way, a node MUST verify that the resulting route being returned in the Route Reply, after this concatenation, contains no duplicate nodes listed in the route record. For example, the figure below illustrates a case in which a Route Request for target E has been received by node F, and node F already has in its Route Cache a route from itself to E:

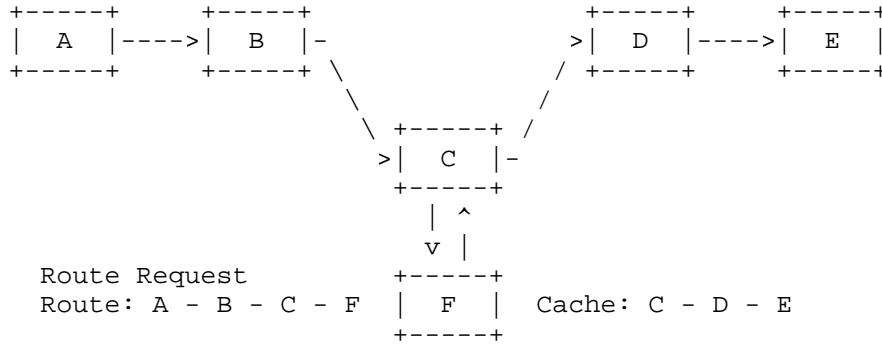

The concatenation of the accumulated route record from the Route Request and the cached route from F's Route Cache would include a duplicate node in passing from C to F and back to C.

Node F in this case could attempt to edit the route to eliminate the duplication, resulting in a route from A to B to C to D and on to E, but in this case, node F would not be on the route that it returned in its own Route Reply. DSR Route Discovery prohibits node F from returning such a Route Reply from its cache; this prohibition increases the probability that the resulting route is valid, since node F in this case should have received a Route Error if the route had previously stopped working. Furthermore, this prohibition means that a future Route Error traversing the route is very likely to pass through any node that sent the Route Reply for the route (including node F), which helps to ensure that stale data is removed from caches (such as at F) in a timely manner; otherwise, the next Route Discovery initiated by A might also be contaminated by a Route Reply from F containing the same stale route. If, due to this restriction on returning a Route Reply based on information from its Route Cache, node F does not return such a Route Reply, it propagates the Route Request normally.

3.3.3. Route Request Hop Limits

Each Route Request message contains a "hop limit" that may be used to limit the number of intermediate nodes allowed to forward that copy of the Route Request. This hop limit is implemented using the Time-to-Live (TTL) field in the IP header of the packet carrying the Route Request. As the Request is forwarded, this limit is decremented, and the Request packet is discarded if the limit reaches zero before finding the target. This Route Request hop limit can be used to implement a variety of algorithms for controlling the spread of a Route Request during a Route Discovery attempt.

For example, a node MAY use this hop limit to implement a "non-propagating" Route Request as an initial phase of a Route Discovery. A node using this technique sends its first Route Request attempt for some target node using a hop limit of 1, such that any node receiving the initial transmission of the Route Request will not forward the Request to other nodes by re-broadcasting it. This form of Route Request is called a "non-propagating" Route Request; it provides an inexpensive method for determining if the target is currently a neighbor of the initiator or if a neighbor node has a route to the target cached (effectively using the neighbors' Route Caches as an extension of the initiator's own Route Cache). If no Route Reply is received after a short timeout, then the node sends a "propagating" Route Request for the target node (i.e., with hop limit as defined by the value of the `DiscoveryHopLimit` configuration variable).

As another example, a node MAY use this hop limit to implement an "expanding ring" search for the target [JOHNSON96a]. A node using this technique sends an initial non-propagating Route Request as described above; if no Route Reply is received for it, the node originates another Route Request with a hop limit of 2. For each Route Request originated, if no Route Reply is received for it, the node doubles the hop limit used on the previous attempt, to progressively explore for the target node without allowing the Route Request to propagate over the entire network. However, this expanding ring search approach could increase the average latency of Route Discovery, since multiple Discovery attempts and timeouts may be needed before discovering a route to the target node.

3.4. Additional Route Maintenance Features

3.4.1. Packet Salvaging

When an intermediate node forwarding a packet detects through Route Maintenance that the next hop along the route for that packet is broken, if the node has another route to the packet's destination in its Route Cache, the node SHOULD "salvage" the packet rather than discard it. To salvage a packet, the node replaces the original source route on the packet with a route from its Route Cache. The node then forwards the packet to the next node indicated along this source route. For example, in the situation shown in the example of Section 3.2, if node C has another route cached to node E, it can salvage the packet by replacing the original route in the packet with this new route from its own Route Cache rather than discarding the packet.

When salvaging a packet, a count is maintained in the packet of the number of times that it has been salvaged, to prevent a single packet from being salvaged endlessly. Otherwise, since the TTL is

decremented only once by each node, a single node could salvage a packet an unbounded number of times. Even if we chose to require the TTL to be decremented on each salvage attempt, packet salvaging is an expensive operation, so it is desirable to bound the maximum number of times a packet can be salvaged independently of the maximum number of hops a packet can traverse.

As described in Section 3.2, an intermediate node, such as in this case, that detects through Route Maintenance that the next hop along the route for a packet that it is forwarding is broken, the node also SHOULD return a Route Error to the original sender of the packet, identifying the link over which the packet could not be forwarded. If the node sends this Route Error, it SHOULD originate the Route Error before salvaging the packet.

3.4.2. Queued Packets Destined over a Broken Link

When an intermediate node forwarding a packet detects through Route Maintenance that the next-hop link along the route for that packet is broken, in addition to handling that packet as defined for Route Maintenance, the node SHOULD also handle in a similar way any pending packets that it has queued that are destined over this new broken link. Specifically, the node SHOULD search its Network Interface Queue and Maintenance Buffer (Section 4.5) for packets for which the next-hop link is this new broken link. For each such packet currently queued at this node, the node SHOULD process that packet as follows:

- Remove the packet from the node's Network Interface Queue and Maintenance Buffer.
- Originate a Route Error for this packet to the original sender of the packet, using the procedure described in Section 8.3.4, as if the node had already reached the maximum number of retransmission attempts for that packet for Route Maintenance. However, in sending such Route Errors for queued packets in response to detection of a single, new broken link, the node SHOULD send no more than one Route Error to each original sender of any of these packets.
- If the node has another route to the packet's IP Destination Address in its Route Cache, the node SHOULD salvage the packet as described in Section 8.3.6. Otherwise, the node SHOULD discard the packet.

3.4.3. Automatic Route Shortening

Source routes in use MAY be automatically shortened if one or more intermediate nodes in the route become no longer necessary. This mechanism of automatically shortening routes in use is somewhat similar to the use of passive acknowledgements [JUBIN87]. In particular, if a node is able to overhear a packet carrying a source route (e.g., by operating its network interface in promiscuous receive mode), then this node examines the unexpanded portion of that source route. If this node is not the intended next-hop destination for the packet but is named in the later unexpanded portion of the packet's source route, then it can infer that the intermediate nodes before itself in the source route are no longer needed in the route. For example, the figure below illustrates an example in which node D has overheard a data packet being transmitted from B to C, for later forwarding to D and to E:

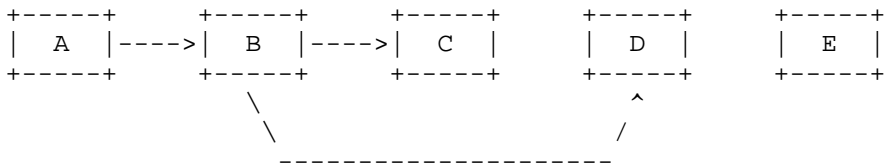

In this case, this node (node D) SHOULD return a "gratuitous" Route Reply to the original sender of the packet (node A). The Route Reply gives the shorter route as the concatenation of the portion of the original source route up through the node that transmitted the overheard packet (node B), plus the suffix of the original source route beginning with the node returning the gratuitous Route Reply (node D). In this example, the route returned in the gratuitous Route Reply message sent from D to A gives the new route as the sequence of hops from A to B to D to E.

When deciding whether to return a gratuitous Route Reply in this way, a node MAY factor in additional information beyond the fact that it was able to overhear the packet. For example, the node MAY decide to return the gratuitous Route Reply only when the overheard packet is received with a signal strength or signal-to-noise ratio above some specific threshold. In addition, each node maintains a Gratuitous Route Reply Table, as described in Section 4.4, to limit the rate at which it originates gratuitous Route Replies for the same returned route.

3.4.4. Increased Spreading of Route Error Messages

When a source node receives a Route Error for a data packet that it originated, this source node propagates this Route Error to its neighbors by piggybacking it on its next Route Request. In this way, stale information in the caches of nodes around this source node will not generate Route Replies that contain the same invalid link for which this source node received the Route Error.

For example, in the situation shown in the example of Section 3.2, node A learns from the Route Error message from C that the link from C to D is currently broken. It thus removes this link from its own Route Cache and initiates a new Route Discovery (if it has no other route to E in its Route Cache). On the Route Request packet initiating this Route Discovery, node A piggybacks a copy of this Route Error, ensuring that the Route Error spreads well to other nodes, and guaranteeing that any Route Reply that it receives (including those from other node's Route Caches) in response to this Route Request does not contain a route that assumes the existence of this broken link.

3.5. Optional DSR Flow State Extension

This section describes an optional, compatible extension to the DSR protocol, known as "flow state", that allows the routing of most packets without an explicit source route header in the packet. The DSR flow state extension further reduces the overhead of the protocol yet still preserves the fundamental properties of DSR's operation. Once a sending node has discovered a source route such as through DSR's Route Discovery mechanism, the flow state mechanism allows the sending node to establish hop-by-hop forwarding state within the network, based on this source route, to enable each node along the route to forward the packet to the next hop based on the node's own local knowledge of the flow along which this packet is being routed. Flow state is dynamically initialized by the first packet using a source route and is then able to route subsequent packets along the same flow without use of a source route header in the packet. The state established at each hop along a flow is "soft state" and thus automatically expires when no longer needed and can be quickly recreated as necessary. Extending DSR's basic operation based on an explicit source route in the header of each packet routed, the flow state extension operates as a form of "implicit source routing" by preserving DSR's basic operation but removing the explicit source route from packets.

3.5.1. Flow Establishment

A source node sending packets to some destination node MAY use the DSR flow state extension described here to establish a route to that destination as a flow. A "flow" is a route from the source to the destination represented by hop-by-hop forwarding state within the nodes along the route. Each flow is uniquely identified by a combination of the source node address, the destination node address, and a flow identifier (flow ID) chosen by the source node.

Each flow ID is a 16-bit unsigned integer. Comparison between different flow IDs MUST be performed modulo 2^{16} . For example, using an implementation in the C programming language, a flow ID value (a) is greater than another flow ID value (b) if $((\text{short})(a) - (b)) > 0$, if a C language "short" data type is implemented as a 16-bit signed integer.

A DSR Flow State header in a packet identifies the flow ID to be followed in forwarding that packet. From a given source to some destination, any number of different flows MAY exist and be in use, for example, following different sequences of hops to reach the destination. One of these flows MAY be considered the "default" flow from that source to that destination. If a node receives a packet with neither a DSR Options header specifying the route to be taken (with a Source Route option in the DSR Options header) nor a DSR Flow State header specifying the flow ID to be followed, it is forwarded along the default flow for the source and destination addresses specified in the packet's IP header.

In establishing a new flow, the source node generates a nonzero 16-bit flow ID greater than any unexpired flow IDs for this (source, destination) pair. If the source wishes for this flow to become the default flow, the low bit of the flow ID MUST be set (the flow ID is an odd number); otherwise, the low bit MUST NOT be set (the flow ID is an even number).

The source node establishing the new flow then transmits a packet containing a DSR Options header with a Source Route option. To establish the flow, the source node also MUST include in the packet a DSR Flow State header, with the Flow ID field set to the chosen flow ID for the new flow, and MUST include a Timeout option in the DSR Options header, giving the lifetime after which state information about this flow is to expire. This packet will generally be a normal data packet being sent from this sender to the destination (for example, the first packet sent after discovering the new route) but is also treated as a "flow establishment" packet.

The source node records this flow in its Flow Table for future use, setting the TTL in this Flow Table entry to the value used in the TTL field in the packet's IP header and setting the Lifetime in this entry to the lifetime specified in the Timeout option in the DSR Options header. The TTL field is used for Default Flow Forwarding, as described in Sections 3.5.3 and 3.5.4.

Any further packets sent with this flow ID before the timeout that also contain a DSR Options header with a Source Route option MUST use this same source route in the Source Route option.

3.5.2. Receiving and Forwarding Establishment Packets

Packets intended to establish a flow, as described in Section 3.5.1, contain a DSR Options header with a Source Route option and are forwarded along the indicated route. A node implementing the DSR flow state extension, when receiving and forwarding such a DSR packet, also keeps some state in its own Flow Table to enable it to forward future packets that are sent along this flow with only the flow ID specified. Specifically, if the packet also contains a DSR Flow State header, this packet SHOULD cause an entry to be established for this flow in the Flow Table of each node along the packet's route.

The Hop Count field of the DSR Flow State header is also stored in the Flow Table, as is the lifetime specified in the Timeout option specified in the DSR Options header.

If the Flow ID is odd and there is no flow in the Flow Table with Flow ID greater than the received Flow ID, set the default Flow ID for this (IP Source Address, IP Destination Address) pair to the received Flow ID, and the TTL of the packet is recorded.

The Flow ID option is removed before final delivery of the packet.

3.5.3. Sending Packets along Established Flows

When a flow is established as described in Section 3.5.1, a packet is sent that establishes state in each node along the route. This state is soft; that is, the protocol contains mechanisms for recovering from the loss of this state. However, the use of these mechanisms may result in reduced performance for packets sent along flows with forgotten state. As a result, it is desirable to differentiate behavior based on whether or not the sender is reasonably certain that the flow state exists on each node along the route. We define a flow's state to be "established end-to-end" if the Flow Tables of all nodes on the route contains forwarding information for that flow. While it is impossible to detect whether or not a flow's state has

been established end-to-end without sending packets, implementations may make reasonable assumptions about the retention of flow state and the probability that an establishment packet has been seen by all nodes on the route.

A source wishing to send a packet along an established flow determines if the flow state has been established end-to-end. If it has not, a DSR Options header with Source Route option with this flow's route is added to the packet. The source SHOULD set the Flow ID field of the DSR Flow State header either to the flow ID previously associated with this flow's route or to zero. If it sets the Flow ID field to any other value, it MUST follow the processing steps in Section 3.5.1 for establishing a new flow ID. If it sets the Flow ID field to a nonzero value, it MUST include a Timeout option with a value not greater than the timeout remaining in the node's Flow Table, and if its TTL is not equal to that specified in the Flow Table, the flow MUST NOT be used as a default flow in the future.

Once flow state has been established end-to-end for non-default flows, a source adds a DSR Flow State header to each packet it wishes to send along that flow, setting the Flow ID field to the flow ID of that flow. A Source Route option SHOULD NOT be added to the packet, though if one is, then the steps for processing flows that have not been established end-to-end MUST be followed.

Once flow state has been established end-to-end for default flows, sources sending packets with IP TTL equal to the TTL value in the local Flow Table entry for this flow then transmit the packet to the next hop. In this case, a DSR Flow State header SHOULD NOT be added to the packet and a DSR Options header likewise SHOULD NOT be added to the packet; though if one is, the steps for sending packets along non-default flows MUST be followed. If the IP TTL is not equal to the TTL value in the local Flow Table, then the steps for processing a non-default flow MUST be followed.

3.5.4. Receiving and Forwarding Packets Sent along Established Flows

The handling of packets containing a DSR Options header with both a nonzero Flow ID and a Source Route option is described in Section 3.5.2. The Flow ID is ignored when it is equal to zero. This section only describes handling of packets without a Source Route option.

If a node receives a packet with a Flow ID in the DSR Options header that indicates an unexpired flow in the node's Flow Table, it increments the Hop Count in the DSR Options header and forwards the packet to the next hop indicated in the Flow Table.

If a node receives a packet with a Flow ID that indicates a flow not currently in the node's Flow Table, it returns a Route Error of type UNKNOWN_FLOW with Error Destination and IP Destination addresses copied from the IP Source of the packet triggering the error. This error packet SHOULD be MAC-destined to the node from which the packet was received; if it cannot confirm reachability of the previous node using Route Maintenance, it MUST send the error as described in Section 8.1.1. The node sending the error SHOULD attempt to salvage the packet triggering the Route Error. If it does salvage the packet, it MUST zero the Flow ID in the packet.

If a node receives a packet with no DSR Options header and no DSR Flow State header, it checks the Default Flow Table. If there is a matching entry, it forwards to the next hop indicated in the Flow Table for the default flow. Otherwise, it returns a Route Error of type DEFAULT_FLOW_UNKNOWN with Error Destination and IP Destination addresses copied from the IP Source Address of the packet triggering the error. This error packet SHOULD be MAC-destined to the node from which it was received; if this node cannot confirm reachability of the previous node using Route Maintenance, it MUST send the error as described in Section 8.1.1. The node sending the error SHOULD attempt to salvage the packet triggering the Route Error. If it does salvage the packet, it MUST zero the Flow ID in the packet.

3.5.5. Processing Route Errors

When a node receives a Route Error of type UNKNOWN_FLOW, it marks the flow to indicate that it has not been established end-to-end. When a node receives a Route Error of type DEFAULT_FLOW_UNKNOWN, it marks the default flow to indicate that it has not been established end-to-end.

3.5.6. Interaction with Automatic Route Shortening

Because a full source route is not carried in every packet, an alternative method for performing automatic route shortening is necessary for packets using the flow state extension. Instead, nodes promiscuously listen to packets, and if a node receives a packet with (IP Source, IP Destination, Flow ID) found in the Flow Table but the MAC-layer (next hop) destination address of the packet is not this node, the node determines whether the packet was sent by an upstream or downstream node by examining the Hop Count field in the DSR Flow State header. If the Hop Count field is less than the expected Hop Count at this node (that is, the expected Hop Count field in the Flow Table described in Section 5.1), the node assumes that the packet was sent by an upstream node and adds an entry for the packet to its Automatic Route Shortening Table, possibly evicting an earlier entry added to this table. When the packet is then sent to that node for

forwarding, the node finds that it has previously received the packet by checking its Automatic Route Shortening Table and returns a gratuitous Route Reply to the source of the packet.

3.5.7. Loop Detection

If a node receives a packet for forwarding with TTL lower than expected and default flow forwarding is being used, it sends a Route Error of type DEFAULT_FLOW_UNKNOWN back to the IP source. It can attempt delivery of the packet by normal salvaging (subject to constraints described in Section 8.6.7).

3.5.8. Acknowledgement Destination

In packets sent using Flow State, the previous hop is not necessarily known. In order to allow nodes that have lost flow state to determine the previous hop, the address of the previous hop can optionally be stored in the Acknowledgement Request. This extension SHOULD NOT be used when a Source Route option is present, MAY be used when flow state routing is used without a Source Route option, and SHOULD be used before Route Maintenance determines that the next-hop destination is unreachable.

3.5.9. Crash Recovery

Each node has a maximum Timeout value that it can possibly generate. This can be based on the largest number that can be set in a timeout option ($2^{16} - 1$ seconds) or may be less than this, set in system software. When a node crashes, it does not establish new flows for a period equal to this maximum Timeout value, in order to avoid colliding with its old Flow IDs.

3.5.10. Rate Limiting

Flow IDs can be assigned with a counter. More specifically, the "Current Flow ID" is kept. When a new default Flow ID needs to be assigned, if the Current Flow ID is odd, the Current Flow ID is assigned as the Flow ID and the Current Flow ID is incremented by one; if the Current Flow ID is even, one plus the Current Flow ID is assigned as the Flow ID and the Current Flow ID is incremented by two.

If Flow IDs are assigned in this way, one algorithm for avoiding duplicate, unexpired Flow IDs is to rate limit new Flow IDs to an average rate of n assignments per second, where n is 2^{15} divided by the maximum Timeout value. This can be averaged over any period not exceeding the maximum Timeout value.

3.5.11. Interaction with Packet Salvaging

Salvaging is modified to zero the Flow ID field in the packet. Also, anytime this document refers to the Salvage field in the Source Route option in a DSR Options header, packets without a Source Route option are considered to have the value zero in the Salvage field.

4. Conceptual Data Structures

This document describes the operation of the DSR protocol in terms of a number of conceptual data structures. This section describes each of these data structures and provides an overview of its use in the protocol. In an implementation of the protocol, these data structures MUST be implemented in a manner consistent with the external behavior described in this document, but the choice of implementation used is otherwise unconstrained. Additional conceptual data structures are required for the optional flow state extensions to DSR; these data structures are described in Section 5.

4.1. Route Cache

Each node implementing DSR MUST maintain a Route Cache, containing routing information needed by the node. A node adds information to its Route Cache as it learns of new links between nodes in the ad hoc network; for example, a node may learn of new links when it receives a packet carrying a Route Request, Route Reply, or DSR source route. Likewise, a node removes information from its Route Cache as it learns that existing links in the ad hoc network have broken. For example, a node may learn of a broken link when it receives a packet carrying a Route Error or through the link-layer retransmission mechanism reporting a failure in forwarding a packet to its next-hop destination.

Anytime a node adds new information to its Route Cache, the node SHOULD check each packet in its own Send Buffer (Section 4.2) to determine whether a route to that packet's IP Destination Address now exists in the node's Route Cache (including the information just added to the Cache). If so, the packet SHOULD then be sent using that route and removed from the Send Buffer.

It is possible to interface a DSR network with other networks, external to this DSR network. Such external networks may, for example, be the Internet or may be other ad hoc networks routed with a routing protocol other than DSR. Such external networks may also be other DSR networks that are treated as external networks in order to improve scalability. The complete handling of such external networks is beyond the scope of this document. However, this document specifies a minimal set of requirements and features

necessary to allow nodes only implementing this specification to interoperate correctly with nodes implementing interfaces to such external networks. This minimal set of requirements and features involve the First Hop External (F) and Last Hop External (L) bits in a DSR Source Route option (Section 6.7) and a Route Reply option (Section 6.3) in a packet's DSR Options header (Section 6). These requirements also include the addition of an External flag bit tagging each link in the Route Cache, copied from the First Hop External (F) and Last Hop External (L) bits in the DSR Source Route option or Route Reply option from which this link was learned.

The Route Cache SHOULD support storing more than one route to each destination. In searching the Route Cache for a route to some destination node, the Route Cache is searched by destination node address. The following properties describe this searching function on a Route Cache:

- Each implementation of DSR at any node MAY choose any appropriate strategy and algorithm for searching its Route Cache and selecting a "best" route to the destination from among those found. For example, a node MAY choose to select the shortest route to the destination (the shortest sequence of hops), or it MAY use an alternate metric to select the route from the Cache.
- However, if there are multiple cached routes to a destination, the selection of routes when searching the Route Cache SHOULD prefer routes that do not have the External flag set on any link. This preference will select routes that lead directly to the target node over routes that attempt to reach the target via any external networks connected to the DSR ad hoc network.
- In addition, any route selected when searching the Route Cache MUST NOT have the External bit set for any links other than possibly the first link, the last link, or both; the External bit MUST NOT be set for any intermediate hops in the route selected.

An implementation of a Route Cache MAY provide a fixed capacity for the cache, or the cache size MAY be variable. The following properties describe the management of available space within a node's Route Cache:

- Each implementation of DSR at each node MAY choose any appropriate policy for managing the entries in its Route Cache, such as when limited cache capacity requires a choice of which entries to retain in the Cache. For example, a node MAY chose a "least recently used" (LRU) cache replacement policy, in which the entry

last used longest ago is discarded from the cache if a decision needs to be made to allow space in the cache for some new entry being added.

- However, the Route Cache replacement policy SHOULD allow routes to be categorized based upon "preference", where routes with a higher preference are less likely to be removed from the cache. For example, a node could prefer routes for which it initiated a Route Discovery over routes that it learned as the result of promiscuous snooping on other packets. In particular, a node SHOULD prefer routes that it is presently using over those that it is not.

Any suitable data structure organization, consistent with this specification, MAY be used to implement the Route Cache in any node. For example, the following two types of organization are possible:

- In DSR, the route returned in each Route Reply that is received by the initiator of a Route Discovery (or that is learned from the header of overhead packets, as described in Section 8.1.4) represents a complete path (a sequence of links) leading to the destination node. By caching each of these paths separately, a "path cache" organization for the Route Cache can be formed. A path cache is very simple to implement and easily guarantees that all routes are loop-free, since each individual route from a Route Reply or Route Request or used in a packet is loop-free. To search for a route in a path cache data structure, the sending node can simply search its Route Cache for any path (or prefix of a path) that leads to the intended destination node.

This type of organization for the Route Cache in DSR has been extensively studied through simulation [BROCH98, HU00, JOHANSSON99, MALTZ99a] and through implementation of DSR in a mobile outdoor testbed under significant workload [MALTZ99b, MALTZ00, MALTZ01].

- Alternatively, a "link cache" organization could be used for the Route Cache, in which each individual link (hop) in the routes returned in Route Reply packets (or otherwise learned from the header of overhead packets) is added to a unified graph data structure of this node's current view of the network topology. To search for a route in link cache, the sending node must use a more complex graph search algorithm, such as the well-known Dijkstra's shortest-path algorithm, to find the current best path through the graph to the destination node. Such an algorithm is more difficult to implement and may require significantly more CPU time to execute.

However, a link cache organization is more powerful than a path cache organization, in its ability to effectively utilize all of the potential information that a node might learn about the state of the network. In particular, links learned from different Route Discoveries or from the header of any overheard packets can be merged together to form new routes in the network, but this is not possible in a path cache due to the separation of each individual path in the cache.

This type of organization for the Route Cache in DSR, including the effect of a range of implementation choices, has been studied through detailed simulation [HU00].

The choice of data structure organization to use for the Route Cache in any DSR implementation is a local matter for each node and affects only performance; any reasonable choice of organization for the Route Cache does not affect either correctness or interoperability.

Each entry in the Route Cache SHOULD have a timeout associated with it, to allow that entry to be deleted if not used within some time. The particular choice of algorithm and data structure used to implement the Route Cache SHOULD be considered in choosing the timeout for entries in the Route Cache. The configuration variable RouteCacheTimeout defined in Section 9 specifies the timeout to be applied to entries in the Route Cache, although it is also possible to instead use an adaptive policy in choosing timeout values rather than using a single timeout setting for all entries. For example, the Link-MaxLife cache design (below) uses an adaptive timeout algorithm and does not use the RouteCacheTimeout configuration variable.

As guidance to implementers, Appendix A describes a type of link cache known as "Link-MaxLife" that has been shown to outperform other types of link caches and path caches studied in detailed simulation [HU00]. Link-MaxLife is an adaptive link cache in which each link in the cache has a timeout that is determined dynamically by the caching node according to its observed past behavior of the two nodes at the ends of the link. In addition, when selecting a route for a packet being sent to some destination, among cached routes of equal length (number of hops) to that destination, Link-MaxLife selects the route with the longest expected lifetime (highest minimum timeout of any link in the route). Use of the Link-MaxLife design for the Route Cache is recommended in implementations of DSR.

4.2. Send Buffer

The Send Buffer of a node implementing DSR is a queue of packets that cannot be sent by that node because it does not yet have a source route to each such packet's destination. Each packet in the Send Buffer is logically associated with the time that it was placed into the buffer and SHOULD be removed from the Send Buffer and silently discarded after a period of `SendBufferTimeout` after initially being placed in the buffer. If necessary, a FIFO strategy SHOULD be used to evict packets before they time out to prevent the buffer from overflowing.

Subject to the rate limiting defined in Section 4.3, a Route Discovery SHOULD be initiated as often as allowed for the destination address of any packets residing in the Send Buffer.

4.3. Route Request Table

The Route Request Table of a node implementing DSR records information about Route Requests that have been recently originated or forwarded by this node. The table is indexed by IP address.

The Route Request Table on a node records the following information about nodes to which this node has initiated a Route Request:

- The Time-to-Live (TTL) field used in the IP header of the Route Request for the last Route Discovery initiated by this node for that target node. This value allows the node to implement a variety of algorithms for controlling the spread of its Route Request on each Route Discovery initiated for a target. As examples, two possible algorithms for this use of the TTL field are described in Section 3.3.3.
- The time that this node last originated a Route Request for that target node.
- The number of consecutive Route Discoveries initiated for this target since receiving a valid Route Reply giving a route to that target node.
- The remaining amount of time before which this node MAY next attempt at a Route Discovery for that target node. When the node initiates a new Route Discovery for this target node, this field in the Route Request Table entry for that target node is initialized to the timeout for that Route Discovery, after which the node MAY initiate a new Discovery for that target. Until a valid Route Reply is received for this target node address, a node MUST implement a back-off algorithm in determining this timeout

value for each successive Route Discovery initiated for this target using the same Time-to-Live (TTL) value in the IP header of the Route Request packet. The timeout between such consecutive Route Discovery initiations SHOULD increase by doubling the timeout value on each new initiation.

In addition, the Route Request Table on a node also records the following information about initiator nodes from which this node has received a Route Request:

- A FIFO cache of size RequestTableIds entries containing the Identification value and target address from the most recent Route Requests received by this node from that initiator node.

Nodes SHOULD use an LRU policy to manage the entries in their Route Request Table.

The number of Identification values to retain in each Route Request Table entry, RequestTableIds, MUST NOT be unlimited, since, in the worst case, when a node crashes and reboots, the first RequestTableIds Route Discoveries it initiates after rebooting could appear to be duplicates to the other nodes in the network. In addition, a node SHOULD base its initial Identification value, used for Route Discoveries after rebooting, on a battery backed-up clock or other persistent memory device, if available, in order to help avoid any possible such delay in successfully discovering new routes after rebooting; if no such source of initial Identification value is available, a node after rebooting SHOULD base its initial Identification value on a random number.

4.4. Gratuitous Route Reply Table

The Gratuitous Route Reply Table of a node implementing DSR records information about "gratuitous" Route Replies sent by this node as part of automatic route shortening. As described in Section 3.4.3, a node returns a gratuitous Route Reply when it overhears a packet transmitted by some node, for which the node overhearing the packet was not the intended next-hop node but was named later in the unexpended hops of the source route in that packet; the node overhearing the packet returns a gratuitous Route Reply to the original sender of the packet, listing the shorter route (not including the hops of the source route "skipped over" by this packet). A node uses its Gratuitous Route Reply Table to limit the rate at which it originates gratuitous Route Replies to the same original sender for the same node from which it overheard a packet to trigger the gratuitous Route Reply.

Each entry in the Gratuitous Route Reply Table of a node contains the following fields:

- The address of the node to which this node originated a gratuitous Route Reply.
- The address of the node from which this node overheard the packet triggering that gratuitous Route Reply.
- The remaining time before which this entry in the Gratuitous Route Reply Table expires and SHOULD be deleted by the node. When a node creates a new entry in its Gratuitous Route Reply Table, the timeout value for that entry SHOULD be initialized to the value `GratReplyHoldoff`.

When a node overhears a packet that would trigger a gratuitous Route Reply, if a corresponding entry already exists in the node's Gratuitous Route Reply Table, then the node SHOULD NOT send a gratuitous Route Reply for that packet. Otherwise (i.e., if no corresponding entry already exists), the node SHOULD create a new entry in its Gratuitous Route Reply Table to record that gratuitous Route Reply, with a timeout value of `GratReplyHoldoff`.

4.5. Network Interface Queue and Maintenance Buffer

Depending on factors such as the structure and organization of the operating system, protocol stack implementation, network interface device driver, and network interface hardware, a packet being transmitted could be queued in a variety of ways. For example, outgoing packets from the network protocol stack might be queued at the operating system or link layer, before transmission by the network interface. The network interface might also provide a retransmission mechanism for packets, such as occurs in IEEE 802.11 [IEEE80211]; the DSR protocol, as part of Route Maintenance, requires limited buffering of packets already transmitted for which the reachability of the next-hop destination has not yet been determined. The operation of DSR is defined here in terms of two conceptual data structures that, together, incorporate this queuing behavior.

The Network Interface Queue of a node implementing DSR is an output queue of packets from the network protocol stack waiting to be transmitted by the network interface; for example, in the 4.4BSD Unix network protocol stack implementation, this queue for a network interface is represented as a "struct ifqueue" [WRIGHT95]. This queue is used to hold packets while the network interface is in the process of transmitting another packet.

The Maintenance Buffer of a node implementing DSR is a queue of packets sent by this node that are awaiting next-hop reachability confirmation as part of Route Maintenance. For each packet in the Maintenance Buffer, a node maintains a count of the number of retransmissions and the time of the last retransmission. Packets are added to the Maintenance buffer after the first transmission attempt is made. The Maintenance Buffer MAY be of limited size; when adding a new packet to the Maintenance Buffer, if the buffer size is insufficient to hold the new packet, the new packet SHOULD be silently discarded. If, after MaxMaintRexmt attempts to confirm next-hop reachability of some node, no confirmation is received, all packets in this node's Maintenance Buffer with this next-hop destination SHOULD be removed from the Maintenance Buffer. In this case, the node also SHOULD originate a Route Error for this packet to each original source of a packet removed in this way (Section 8.3) and SHOULD salvage each packet removed in this way (Section 8.3.6) if it has another route to that packet's IP Destination Address in its Route Cache. The definition of MaxMaintRexmt conceptually includes any retransmissions that might be attempted for a packet at the link layer or within the network interface hardware. The timeout value to use for each transmission attempt for an acknowledgement request depends on the type of acknowledgement mechanism used by Route Maintenance for that attempt, as described in Section 8.3.

4.6. Blacklist

When a node using the DSR protocol is connected through a network interface that requires physically bidirectional links for unicast transmission, the node MUST maintain a blacklist. The blacklist is a table, indexed by neighbor node address, that indicates that the link between this node and the specified neighbor node may not be bidirectional. A node places another node's address in this list when it believes that broadcast packets from that other node reach this node, but that unicast transmission between the two nodes is not possible. For example, if a node forwarding a Route Reply discovers that the next hop is unreachable, it places that next hop in the node's blacklist.

Once a node discovers that it can communicate bidirectionally with one of the nodes listed in the blacklist, it SHOULD remove that node from the blacklist. For example, if node A has node B listed in its blacklist, but after transmitting a Route Request, node A hears B forward the Route Request with a route record indicating that the broadcast from A to B was successful, then A SHOULD remove the entry for node B from its blacklist.

A node MUST associate a state with each node listed in its blacklist, specifying whether the unidirectionality of the link to that node is "questionable" or "probable". Each time the unreachability is positively determined, the node SHOULD set the state to "probable". After the unreachability has not been positively determined for some amount of time, the state SHOULD revert to "questionable". A node MAY expire entries for nodes from its blacklist after a reasonable amount of time.

5. Additional Conceptual Data Structures for Flow State Extension

This section defines additional conceptual data structures used by the optional "flow state" extension to DSR. In an implementation of the protocol, these data structures MUST be implemented in a manner consistent with the external behavior described in this document, but the choice of implementation used is otherwise unconstrained.

5.1. Flow Table

A node implementing the flow state extension MUST implement a Flow Table or other data structure consistent with the external behavior described in this section. A node not implementing the flow state extension SHOULD NOT implement a Flow Table.

The Flow Table records information about flows from which packets recently have been sent or forwarded by this node. The table is indexed by a triple (IP Source Address, IP Destination Address, Flow ID), where Flow ID is a 16-bit number assigned by the source as described in Section 3.5.1. Each entry in the Flow Table contains the following fields:

- The MAC address of the next-hop node along this flow.
- An indication of the outgoing network interface on this node to be used in transmitting packets along this flow.
- The MAC address of the previous-hop node along this flow.
- An indication of the network interface on this node from which packets from that previous-hop node are received.
- A timeout after which this entry in the Flow Table MUST be deleted.
- The expected value of the Hop Count field in the DSR Flow State header for packets received for forwarding along this field (for use with packets containing a DSR Flow State header).

- An indication of whether or not this flow can be used as a default flow for packets originated by this node (the Flow ID of a default flow MUST be odd).
- The entry SHOULD record the complete source route for the flow. (Nodes not recording the complete source route cannot participate in Automatic Route Shortening.)
- The entry MAY contain a field recording the time this entry was last used.

The entry MUST be deleted when its timeout expires.

5.2. Automatic Route Shortening Table

A node implementing the flow state extension SHOULD implement an Automatic Route Shortening Table or other data structure consistent with the external behavior described in this section. A node not implementing the flow state extension SHOULD NOT implement an Automatic Route Shortening Table.

The Automatic Route Shortening Table records information about received packets for which Automatic Route Shortening may be possible. The table is indexed by a triple (IP Source Address, IP Destination Address, Flow ID). Each entry in the Automatic Route Shortening Table contains a list of (packet identifier, Hop Count) pairs for that flow. The packet identifier in the list may be any unique identifier for the received packet; for example, for IPv4 packets, the combination of the following fields from the packet's IP header MAY be used as a unique identifier for the packet: Source Address, Destination Address, Identification, Protocol, Fragment Offset, and Total Length. The Hop Count in the list in the entry is copied from the Hop Count field in the DSR Flow State header of the received packet for which this table entry was created. Any packet identifier SHOULD appear at most once in an entry's list, and this list item SHOULD record the minimum Hop Count value received for that packet (if the wireless signal strength or signal-to-noise ratio at which a packet is received is available to the DSR implementation in a node, the node MAY, for example, remember instead in this list the minimum Hop Count value for which the received packet's signal strength or signal-to-noise ratio exceeded some threshold).

Space in the Automatic Route Shortening Table of a node MAY be dynamically managed by any local algorithm at the node. For example, in order to limit the amount of memory used to store the table, any existing entry MAY be deleted at any time, and the number of packets listed in each entry MAY be limited. However, when reclaiming space in the table, nodes SHOULD favor retaining information about more

flows in the table rather than about more packets listed in each entry in the table, as long as at least the listing of some small number of packets (e.g., 3) can be retained in each entry.

5.3. Default Flow ID Table

A node implementing the flow state extension MUST implement a Default Flow Table or other data structure consistent with the external behavior described in this section. A node not implementing the flow state extension SHOULD NOT implement a Default Flow Table.

For each (IP Source Address, IP Destination Address) pair for which a node forwards packets, the node MUST record:

- The largest odd Flow ID value seen.
- The time at which all the corresponding flows that are forwarded by this node expire.
- The current default Flow ID.
- A flag indicating whether or not the current default Flow ID is valid.

If a node deletes this record for an (IP Source Address, IP Destination Address) pair, it MUST also delete all Flow Table entries for that pair. Nodes MUST delete table entries if all of this (IP Source Address, IP Destination Address) pair's flows that are forwarded by this node expire.

6. DSR Options Header Format

The Dynamic Source Routing protocol makes use of a special header carrying control information that can be included in any existing IP packet. This DSR Options header in a packet contains a small fixed-sized, 4-octet portion, followed by a sequence of zero or more DSR options carrying optional information. The end of the sequence of DSR options in the DSR Options header is implied by the total length of the DSR Options header.

For IPv4, the DSR Options header MUST immediately follow the IP header in the packet. (If a Hop-by-Hop Options extension header, as defined in IPv6 [RFC2460], becomes defined for IPv4, the DSR Options header MUST immediately follow the Hop-by-Hop Options extension header, if one is present in the packet, and MUST otherwise immediately follow the IP header.)

To add a DSR Options header to a packet, the DSR Options header is inserted following the packet's IP header, before any following header such as a traditional (e.g., TCP or UDP) transport layer header. Specifically, the Protocol field in the IP header is used to indicate that a DSR Options header follows the IP header, and the Next Header field in the DSR Options header is used to indicate the type of protocol header (such as a transport layer header) following the DSR Options header.

If any headers follow the DSR Options header in a packet, the total length of the DSR Options header (and thus the total, combined length of all DSR options present) MUST be a multiple of 4 octets. This requirement preserves the alignment of these following headers in the packet.

6.1. Fixed Portion of DSR Options Header

The fixed portion of the DSR Options header is used to carry information that must be present in any DSR Options header. This fixed portion of the DSR Options header has the following format:

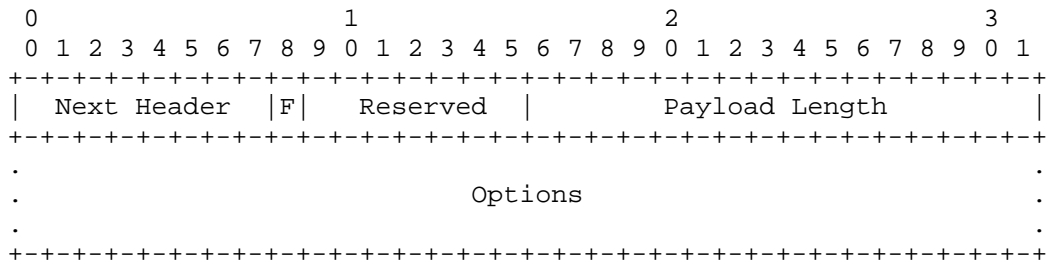

Next Header

8-bit selector. Identifies the type of header immediately following the DSR Options header. Uses the same values as the IPv4 Protocol field [RFC1700]. If no header follows, then Next Header MUST have the value 59, "No Next Header" [RFC2460].

Flow State Header (F)

Flag bit. MUST be set to 0. This bit is set in a DSR Flow State header (Section 7.1) and clear in a DSR Options header.

Reserved

MUST be sent as 0 and ignored on reception.

Payload Length

The length of the DSR Options header, excluding the 4-octet fixed portion. The value of the Payload Length field defines the total length of all options carried in the DSR Options header.

Options

Variable-length field; the length of the Options field is specified by the Payload Length field in this DSR Options header. Contains one or more pieces of optional information (DSR options), encoded in type-length-value (TLV) format (with the exception of the Pad1 option described in Section 6.8).

The placement of DSR options following the fixed portion of the DSR Options header MAY be padded for alignment. However, due to the typically limited available wireless bandwidth in ad hoc networks, this padding is not required, and receiving nodes MUST NOT expect options within a DSR Options header to be aligned.

Each DSR option is assigned a unique Option Type code. The most significant 3 bits (that is, Option Type & 0xE0) allow a node not implementing processing for this Option Type value to behave in the manner closest to correct for that type:

- The most significant bit in the Option Type value (that is, Option Type & 0x80) represents whether or not a node receiving this Option Type (when the node does not implement processing for this Option Type) SHOULD respond to such a DSR option with a Route Error of type OPTION_NOT_SUPPORTED, except that such a Route Error SHOULD never be sent in response to a packet containing a Route Request option.
- The two following bits in the Option Type value (that is, Option Type & 0x60) are a two-bit field indicating how such a node that does not support this Option Type MUST process the packet:

00 = Ignore Option
01 = Remove Option
10 = Mark Option
11 = Drop Packet

When these 2 bits are 00 (that is, Option Type & 0x60 == 0), a node not implementing processing for that Option Type MUST use the Opt Data Len field to skip over the option and continue processing. When these 2 bits are 01 (that is, Option Type & 0x60 == 0x20), a node not implementing processing for that Option Type

MUST use the Opt Data Len field to remove the option from the packet and continue processing as if the option had not been included in the received packet. When these 2 bits are 10 (that is, Option Type & 0x60 == 0x40), a node not implementing processing for that Option Type MUST set the most significant bit following the Opt Data Len field, MUST ignore the contents of the option using the Opt Data Len field, and MUST continue processing the packet. Finally, when these 2 bits are 11 (that is, Option Type & 0x60 == 0x60), a node not implementing processing for that Option Type MUST drop the packet.

The following types of DSR options are defined in this document for use within a DSR Options header:

- Route Request option (Section 6.2)
- Route Reply option (Section 6.3)
- Route Error option (Section 6.4)
- Acknowledgement Request option (Section 6.5)
- Acknowledgement option (Section 6.6)
- DSR Source Route option (Section 6.7)
- Pad1 option (Section 6.8)
- PadN option (Section 6.9)

In addition, Section 7 specifies further DSR options for use with the optional DSR flow state extension.

6.2. Route Request Option

The Route Request option in a DSR Options header is encoded as follows:

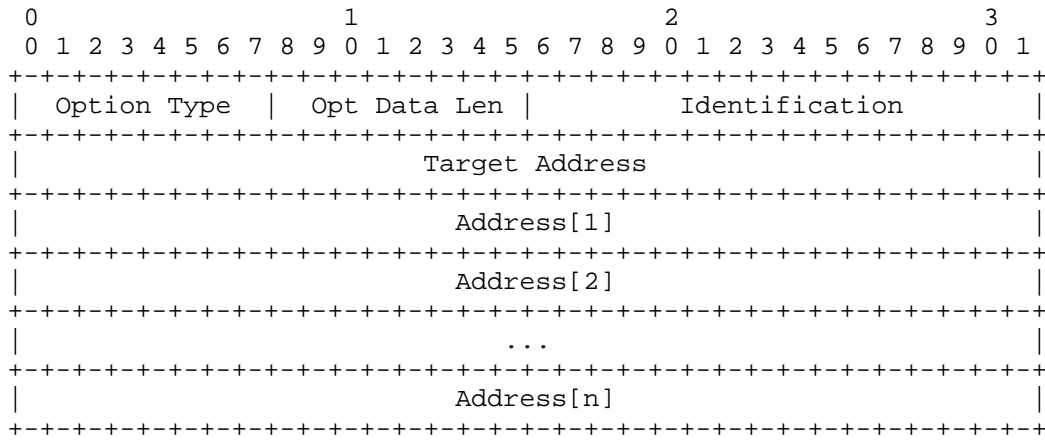

IP fields:

Source Address

MUST be set to the address of the node originating this packet. Intermediate nodes that retransmit the packet to propagate the Route Request MUST NOT change this field.

Destination Address

MUST be set to the IP limited broadcast address (255.255.255.255).

Hop Limit (TTL)

MAY be varied from 1 to 255, for example, to implement non-propagating Route Requests and Route Request expanding-ring searches (Section 3.3.3).

Route Request fields:

Option Type

1. Nodes not understanding this option will ignore this option.

Opt Data Len

8-bit unsigned integer. Length of the option, in octets, excluding the Option Type and Opt Data Len fields. MUST be set equal to $(4 * n) + 6$, where n is the number of addresses in the Route Request Option.

Identification

A unique value generated by the initiator (original sender) of the Route Request. Nodes initiating a Route Request generate a new Identification value for each Route Request, for example based on a sequence number counter of all Route Requests initiated by the node.

This value allows a receiving node to determine whether it has recently seen a copy of this Route Request. If this Identification value (for this IP Source address and Target Address) is found by this receiving node in its Route Request Table (in the cache of Identification values in the entry there for this initiating node), this receiving node MUST discard the Route Request. When a Route Request is propagated, this field MUST be copied from the received copy of the Route Request being propagated.

Target Address

The address of the node that is the target of the Route Request.

Address[1..n]

Address[i] is the IPv4 address of the i -th node recorded in the Route Request option. The address given in the Source Address field in the IP header is the address of the initiator of the Route Discovery and MUST NOT be listed in the Address[i] fields; the address given in Address[1] is thus the IPv4 address of the first node on the path after the initiator. The number of addresses present in this field is indicated by the Opt Data Len field in the option ($n = (\text{Opt Data Len} - 6) / 4$). Each node propagating the Route Request adds its own address to this list, increasing the Opt Data Len value by 4 octets.

The Route Request option MUST NOT appear more than once within a DSR Options header.

6.3. Route Reply Option

The Route Reply option in a DSR Options header is encoded as follows:

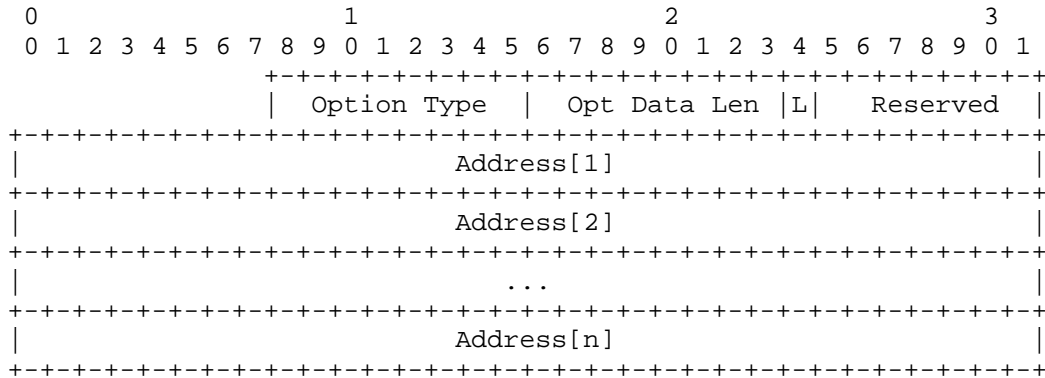

IP fields:

Source Address

Set to the address of the node sending the Route Reply. In the case of a node sending a reply from its Route Cache (Section 3.3.2) or sending a gratuitous Route Reply (Section 3.4.3), this address can differ from the address that was the target of the Route Discovery.

Destination Address

MUST be set to the address of the source node of the route being returned. Copied from the Source Address field of the Route Request generating the Route Reply or, in the case of a gratuitous Route Reply, copied from the Source Address field of the data packet triggering the gratuitous Reply.

Route Reply fields:

Option Type

2. Nodes not understanding this option will ignore this option.

Opt Data Len

8-bit unsigned integer. Length of the option, in octets, excluding the Option Type and Opt Data Len fields. MUST be set equal to $(4 * n) + 1$, where n is the number of addresses in the Route Reply Option.

Last Hop External (L)

Set to indicate that the last hop given by the Route Reply (the link from Address[n-1] to Address[n]) is actually an arbitrary path in a network external to the DSR network; the exact route outside the DSR network is not represented in the Route Reply. Nodes caching this hop in their Route Cache MUST flag the cached hop with the External flag. Such hops MUST NOT be returned in a cached Route Reply generated from this Route Cache entry, and selection of routes from the Route Cache to route a packet being sent SHOULD prefer routes that contain no hops flagged as External.

Reserved

MUST be sent as 0 and ignored on reception.

Address[1..n]

The source route being returned by the Route Reply. The route indicates a sequence of hops, originating at the source node specified in the Destination Address field of the IP header of the packet carrying the Route Reply, through each of the Address[i] nodes in the order listed in the Route Reply, ending at the node indicated by Address[n]. The number of addresses present in the Address[1..n] field is indicated by the Opt Data Len field in the option ($n = (\text{Opt Data Len} - 1) / 4$).

A Route Reply option MAY appear one or more times within a DSR Options header.

6.4. Route Error Option

The Route Error option in a DSR Options header is encoded as follows:

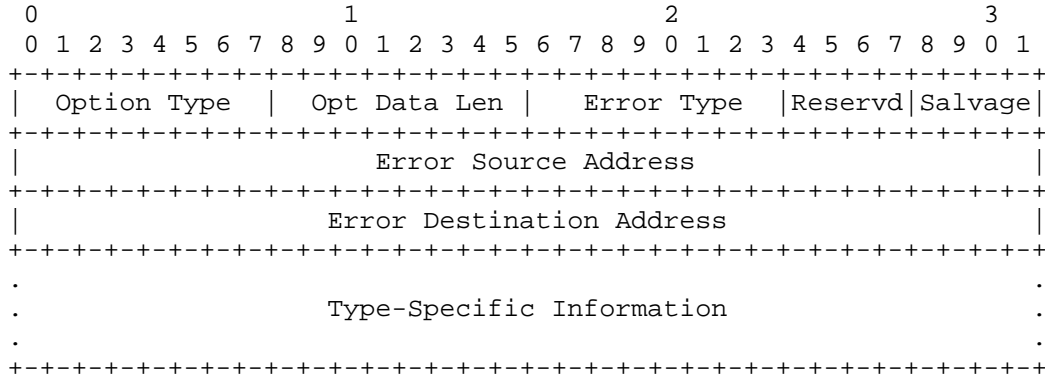

Option Type

3. Nodes not understanding this option will ignore this option.

Opt Data Len

8-bit unsigned integer. Length of the option, in octets, excluding the Option Type and Opt Data Len fields.

For the current definition of the Route Error option, this field MUST be set to 10, plus the size of any Type-Specific Information present in the Route Error. Further extensions to the Route Error option format may also be included after the Type-Specific Information portion of the Route Error option specified above. The presence of such extensions will be indicated by the Opt Data Len field. When the Opt Data Len is greater than that required for the fixed portion of the Route Error plus the necessary Type-Specific Information as indicated by the Option Type value in the option, the remaining octets are interpreted as extensions. Currently, no such further extensions have been defined.

Error Type

The type of error encountered. Currently, the following type values are defined:

- 1 = NODE_UNREACHABLE
- 2 = FLOW_STATE_NOT_SUPPORTED
- 3 = OPTION_NOT_SUPPORTED

Other values of the Error Type field are reserved for future use.

Reservd

Reserved. MUST be sent as 0 and ignored on reception.

Salvage

A 4-bit unsigned integer. Copied from the Salvage field in the DSR Source Route option of the packet triggering the Route Error.

The "total salvage count" of the Route Error option is derived from the value in the Salvage field of this Route Error option and all preceding Route Error options in the packet as follows: the total salvage count is the sum of, for each such Route Error option, one plus the value in the Salvage field of that Route Error option.

Error Source Address

The address of the node originating the Route Error (e.g., the node that attempted to forward a packet and discovered the link failure).

Error Destination Address

The address of the node to which the Route Error must be delivered. For example, when the Error Type field is set to NODE_UNREACHABLE, this field will be set to the address of the node that generated the routing information claiming that the hop from the Error Source Address to Unreachable Node Address (specified in the Type-Specific Information) was a valid hop.

Type-Specific Information

Information specific to the Error Type of this Route Error message.

A Route Error option MAY appear one or more times within a DSR Options header.

6.4.1. Node Unreachable Type-Specific Information

When the Route Error is of type NODE_UNREACHABLE, the Type-Specific Information field is defined as follows:

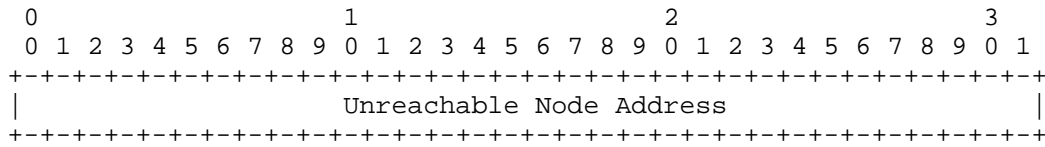

Unreachable Node Address

The IP address of the node that was found to be unreachable (the next-hop neighbor to which the node with address Error Source Address was attempting to transmit the packet).

6.4.2. Flow State Not Supported Type-Specific Information

When the Route Error is of type FLOW_STATE_NOT_SUPPORTED, the Type-Specific Information field is empty.

6.4.3. Option Not Supported Type-Specific Information

When the Route Error is of type OPTION_NOT_SUPPORTED, the Type-Specific Information field is defined as follows:

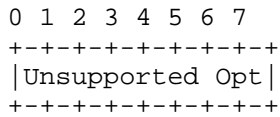

Unsupported Opt

The Option Type of option triggering the Route Error.

6.5. Acknowledgement Request Option

The Acknowledgement Request option in a DSR Options header is encoded as follows:

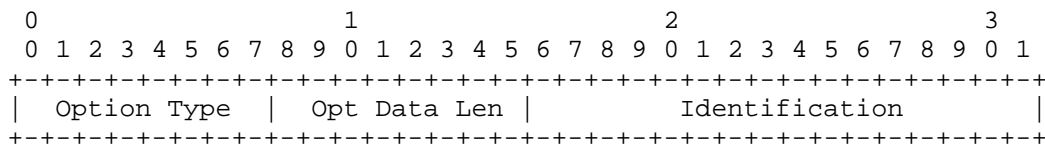

Option Type

160. Nodes not understanding this option will remove the option and return a Route Error.

Opt Data Len

8-bit unsigned integer. Length of the option, in octets, excluding the Option Type and Opt Data Len fields.

Identification

The Identification field is set to a unique value and is copied into the Identification field of the Acknowledgement option when returned by the node receiving the packet over this hop.

An Acknowledgement Request option MUST NOT appear more than once within a DSR Options header.

6.6. Acknowledgement Option

The Acknowledgement option in a DSR Options header is encoded as follows:

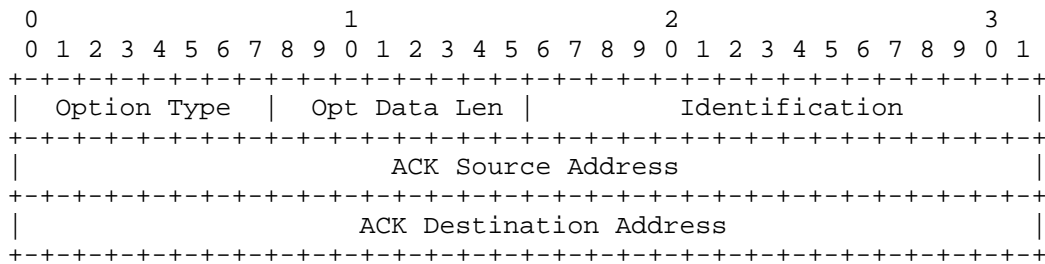

Option Type

32. Nodes not understanding this option will remove the option.

Opt Data Len

8-bit unsigned integer. Length of the option, in octets, excluding the Option Type and Opt Data Len fields.

Identification

Copied from the Identification field of the Acknowledgement Request option of the packet being acknowledged.

ACK Source Address

The address of the node originating the acknowledgement.

ACK Destination Address

The address of the node to which the acknowledgement is to be delivered.

An Acknowledgement option MAY appear one or more times within a DSR Options header.

6.7. DSR Source Route Option

The DSR Source Route option in a DSR Options header is encoded as follows:

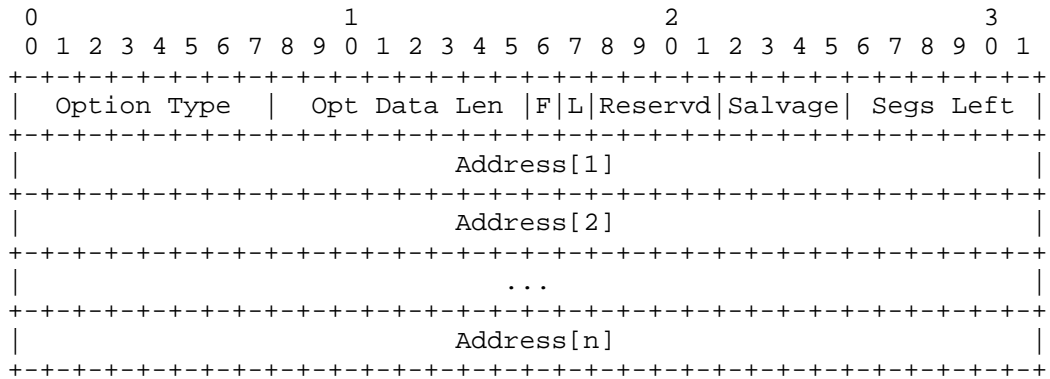

Option Type

96. Nodes not understanding this option will drop the packet.

Opt Data Len

8-bit unsigned integer. Length of the option, in octets, excluding the Option Type and Opt Data Len fields. For the format of the DSR Source Route option defined here, this field MUST be set to the value (n * 4) + 2, where n is the number of addresses present in the Address[i] fields.

First Hop External (F)

Set to indicate that the first hop indicated by the DSR Source Route option is actually an arbitrary path in a network external to the DSR network; the exact route outside the DSR

network is not represented in the DSR Source Route option. Nodes caching this hop in their Route Cache MUST flag the cached hop with the External flag. Such hops MUST NOT be returned in a Route Reply generated from this Route Cache entry, and selection of routes from the Route Cache to route a packet being sent SHOULD prefer routes that contain no hops flagged as External.

Last Hop External (L)

Set to indicate that the last hop indicated by the DSR Source Route option is actually an arbitrary path in a network external to the DSR network; the exact route outside the DSR network is not represented in the DSR Source Route option. Nodes caching this hop in their Route Cache MUST flag the cached hop with the External flag. Such hops MUST NOT be returned in a Route Reply generated from this Route Cache entry, and selection of routes from the Route Cache to route a packet being sent SHOULD prefer routes that contain no hops flagged as External.

Reserved

MUST be sent as 0 and ignored on reception.

Salvage

A 4-bit unsigned integer. Count of number of times that this packet has been salvaged as a part of DSR routing (Section 3.4.1).

Segments Left (Segs Left)

Number of route segments remaining, i.e., number of explicitly listed intermediate nodes still to be visited before reaching the final destination.

Address[1..n]

The sequence of addresses of the source route. In routing and forwarding the packet, the source route is processed as described in Sections 8.1.3 and 8.1.5. The number of addresses present in the Address[1..n] field is indicated by the Opt Data Len field in the option ($n = (\text{Opt Data Len} - 2) / 4$).

When forwarding a packet along a DSR source route using a DSR Source Route option in the packet's DSR Options header, the Destination Address field in the packet's IP header is always set to the address

of the packet's ultimate destination. A node receiving a packet containing a DSR Options header with a DSR Source Route option MUST examine the indicated source route to determine if it is the intended next-hop node for the packet and how to forward the packet, as defined in Sections 8.1.4 and 8.1.5.

6.8. Pad1 Option

The Pad1 option in a DSR Options header is encoded as follows:

```
+-----+
| Option Type |
+-----+
```

Option Type

224. Nodes not understanding this option will drop the packet and return a Route Error.

A Pad1 option MAY be included in the Options field of a DSR Options header in order to align subsequent DSR options, but such alignment is not required and MUST NOT be expected by a node receiving a packet containing a DSR Options header.

If any headers follow the DSR Options header in a packet, the total length of a DSR Options header, indicated by the Payload Length field in the DSR Options header MUST be a multiple of 4 octets. In this case, when building a DSR Options header in a packet, sufficient Pad1 or PadN options MUST be included in the Options field of the DSR Options header to make the total length a multiple of 4 octets.

If more than one consecutive octet of padding is being inserted in the Options field of a DSR Options header, the PadN option described next, SHOULD be used, rather than multiple Pad1 options.

Note that the format of the Pad1 option is a special case; it does not have an Opt Data Len or Option Data field.

6.9. PadN Option

The PadN option in a DSR Options header is encoded as follows:

```
+-----+-----+-----+-----+ - - - - -
| Option Type | Opt Data Len | Option Data
+-----+-----+-----+-----+ - - - - -
```

Option Type

0. Nodes not understanding this option will ignore this option.

Opt Data Len

8-bit unsigned integer. Length of the option, in octets, excluding the Option Type and Opt Data Len fields. The size of the Option Data field.

Option Data

A number of zero-valued octets equal to the Opt Data Len.

A PadN option MAY be included in the Options field of a DSR Options header in order to align subsequent DSR options, but such alignment is not required and MUST NOT be expected by a node receiving a packet containing a DSR Options header.

If any headers follow the DSR Options header in a packet, the total length of a DSR Options header, indicated by the Payload Length field in the DSR Options header, MUST be a multiple of 4 octets. In this case, when building a DSR Options header in a packet, sufficient Pad1 or PadN options MUST be included in the Options field of the DSR Options header to make the total length a multiple of 4 octets.

7. Additional Header Formats and Options for Flow State Extension

The optional DSR flow state extension requires a new header type, the DSR Flow State header.

In addition, the DSR flow state extension adds the following options for the DSR Options header defined in Section 6:

- Timeout option (Section 7.2.1)
- Destination and Flow ID option (Section 7.2.2)

Two new Error Type values are also defined for use in the Route Error option in a DSR Options header:

- UNKNOWN_FLOW
- DEFAULT_FLOW_UNKNOWN

Finally, an extension to the Acknowledgement Request option in a DSR Options header is also defined:

- Previous Hop Address

This section defines each of these new header, option, or extension formats.

7.1. DSR Flow State Header

The DSR Flow State header is a small 4-byte header optionally used to carry the flow ID and hop count for a packet being sent along a DSR flow. It is distinguished from the fixed DSR Options header (Section 6.1) in that the Flow State Header (F) bit is set in the DSR Flow State header and is clear in the fixed DSR Options header.

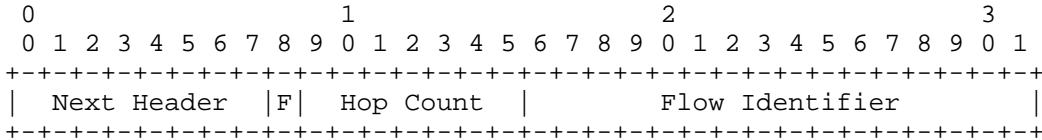

Next Header

8-bit selector. Identifies the type of header immediately following the DSR Flow State header. Uses the same values as the IPv4 Protocol field [RFC1700].

Flow State Header (F)

Flag bit. MUST be set to 1. This bit is set in a DSR Flow State header and clear in a DSR Options header (Section 6.1).

Hop Count

7-bit unsigned integer. The number of hops through which this packet has been forwarded.

Flow Identification

The flow ID for this flow, as described in Section 3.5.1.

7.2. New Options and Extensions in DSR Options Header

7.2.1. Timeout Option

The Timeout option is defined for use in a DSR Options header to indicate the amount of time before the expiration of the flow ID along which the packet is being sent.

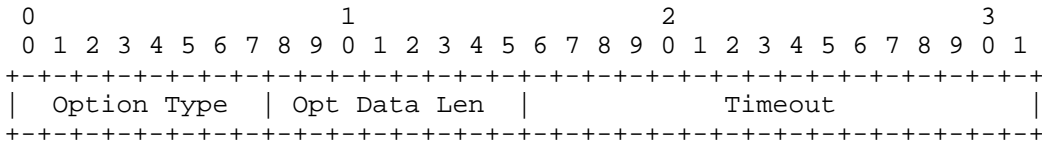

Option Type

128. Nodes not understanding this option will ignore the option and return a Route Error.

Opt Data Len

8-bit unsigned integer. Length of the option, in octets, excluding the Option Type and Opt Data Len fields.

When no extensions are present, the Opt Data Len of a Timeout option is 2. Further extensions to DSR may include additional data in a Timeout option. The presence of such extensions is indicated by an Opt Data Len greater than 2. Currently, no such extensions have been defined.

Timeout

The number of seconds for which this flow remains valid.

The Timeout option MUST NOT appear more than once within a DSR Options header.

7.2.2. Destination and Flow ID Option

The Destination and Flow ID option is defined for use in a DSR Options header to send a packet to an intermediate host along one flow, for eventual forwarding to the final destination along a different flow. This option enables the aggregation of the state of multiple flows.

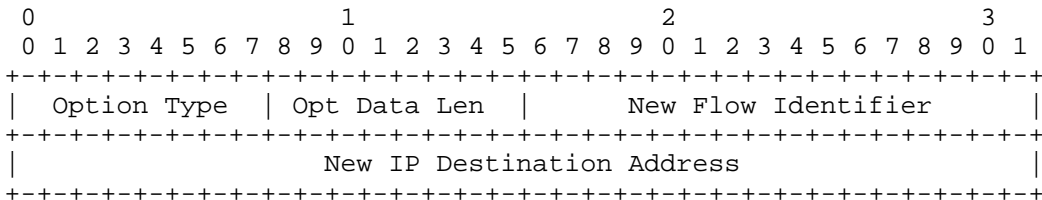

Option Type

129. Nodes not understanding this option will ignore the option and return a Route Error.

Opt Data Len

8-bit unsigned integer. Length of the option, in octets, excluding the Option Type and Opt Data Len fields.

When no extensions are present, the Opt Data Len of a Destination and Flow ID option is 6. Further extensions to DSR may include additional data in a Destination and Flow ID option. The presence of such extensions is indicated by an Opt Data Len greater than 6. Currently, no such extensions have been defined.

New Flow Identifier

Indicates the next identifier to store in the Flow ID field of the DSR Options header.

New IP Destination Address

Indicates the next address to store in the Destination Address field of the IP header.

The Destination and Flow ID option MAY appear one or more times within a DSR Options header.

7.3. New Error Types for Route Error Option

7.3.1. Unknown Flow Type-Specific Information

A new Error Type value of 129 (UNKNOWN_FLOW) is defined for use in a Route Error option in a DSR Options header. The Type-Specific Information for errors of this type is encoded as follows:

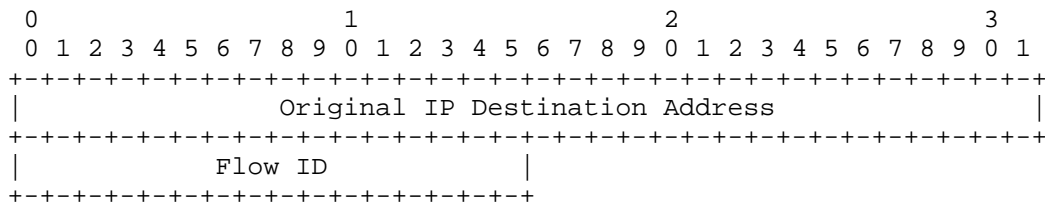

Original IP Destination Address

The IP Destination Address of the packet that caused the error.

Flow ID

The Flow ID contained in the DSR Flow ID option that caused the error.

7.3.2. Default Flow Unknown Type-Specific Information

A new Error Type value of 130 (DEFAULT_FLOW_UNKNOWN) is defined for use in a Route Error option in a DSR Options header. The Type-Specific Information for errors of this type is encoded as follows:

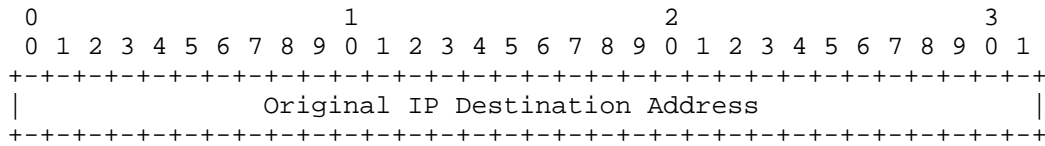

Original IP Destination Address

The IP Destination Address of the packet that caused the error.

7.4. New Acknowledgement Request Option Extension

7.4.1. Previous Hop Address Extension

When the Opt Data Len field of an Acknowledgement Request option in a DSR Options header is greater than or equal to 6, the ACK Request Source Address field is present. The option is then formatted as follows:

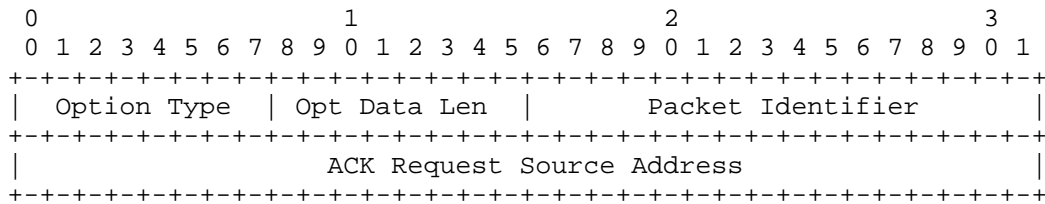

Option Type

160. Nodes not understanding this option will remove the option and return a Route Error.

Opt Data Len

8-bit unsigned integer. Length of the option, in octets, excluding the Option Type and Opt Data Len fields.

When no extensions are presents, the Opt Data Len of an Acknowledgement Request option is 2. Further extensions to DSR may include additional data in an Acknowledgement Request option. The presence of such extensions is indicated by an Opt Data Len greater than 2.

Currently, one such extension has been defined. If the Opt Data Len is at least 6, then an ACK Request Source Address is present.

Packet Identifier

The Packet Identifier field is set to a unique number and is copied into the Identification field of the DSR Acknowledgement option when returned by the node receiving the packet over this hop.

ACK Request Source Address

The address of the node requesting the DSR Acknowledgement.

8. Detailed Operation

8.1. General Packet Processing

8.1.1. Originating a Packet

When originating any packet, a node using DSR routing MUST perform the following sequence of steps:

- Search the node's Route Cache for a route to the address given in the IP Destination Address field in the packet's header.
- If no such route is found in the Route Cache, then perform Route Discovery for the Destination Address, as described in Section 8.2. Initiating a Route Discovery for this target node address results in the node adding a Route Request option in a DSR Options header in this existing packet, or saving this existing packet to its Send Buffer and initiating the Route Discovery by sending a separate packet containing such a Route Request option. If the node chooses to initiate the Route Discovery by adding the Route Request option to this existing packet, it will replace the IP Destination Address field with the IP "limited broadcast" address

(255.255.255.255) [RFC1122], copying the original IP Destination Address to the Target Address field of the new Route Request option added to the packet, as described in Section 8.2.1.

- If the packet now does not contain a Route Request option, then this node must have a route to the Destination Address of the packet; if the node has more than one route to this Destination Address, the node selects one to use for this packet. If the length of this route is greater than 1 hop, or if the node determines to request a DSR network-layer acknowledgement from the first-hop node in that route, then insert a DSR Options header into the packet, as described in Section 8.1.2, and insert a DSR Source Route option, as described in Section 8.1.3. The source route in the packet is initialized from the selected route to the Destination Address of the packet.
- Transmit the packet to the first-hop node address given in selected source route, using Route Maintenance to determine the reachability of the next hop, as described in Section 8.3.

8.1.2. Adding a DSR Options Header to a Packet

A node originating a packet adds a DSR Options header to the packet, if necessary, to carry information needed by the routing protocol. A packet MUST NOT contain more than one DSR Options header. A DSR Options header is added to a packet by performing the following sequence of steps (these steps assume that the packet contains no other headers that MUST be located in the packet before the DSR Options header):

- Insert a DSR Options header after the IP header but before any other header that may be present.
- Set the Next Header field of the DSR Options header to the Protocol number field of the packet's IP header.
- Set the Protocol field of the packet's IP header to the protocol number assigned for DSR (48).

8.1.3. Adding a DSR Source Route Option to a Packet

A node originating a packet adds a DSR Source Route option to the packet, if necessary, in order to carry the source route from this originating node to the final destination address of the packet. Specifically, the node adding the DSR Source Route option constructs the DSR Source Route option and modifies the IP packet according to the following sequence of steps:

- The node creates a DSR Source Route option, as described in Section 6.7, and appends it to the DSR Options header in the packet. (A DSR Options header is added, as described in Section 8.1.2, if not already present.)
- The number of Address[i] fields to include in the DSR Source Route option (n) is the number of intermediate nodes in the source route for the packet (i.e., excluding the address of the originating node and the final destination address of the packet). The Segments Left field in the DSR Source Route option is initialized equal to n.
- The addresses within the source route for the packet are copied into sequential Address[i] fields in the DSR Source Route option, for i = 1, 2, ..., n.
- The First Hop External (F) bit in the DSR Source Route option is copied from the External bit flagging the first hop in the source route for the packet, as indicated in the Route Cache.
- The Last Hop External (L) bit in the DSR Source Route option is copied from the External bit flagging the last hop in the source route for the packet, as indicated in the Route Cache.
- The Salvage field in the DSR Source Route option is initialized to 0.

8.1.4. Processing a Received Packet

When a node receives any packet (whether for forwarding, overheard, or the final destination of the packet), if that packet contains a DSR Options header, then that node MUST process any options contained in that DSR Options header, in the order contained there. Specifically:

- If the DSR Options header contains a Route Request option, the node SHOULD extract the source route from the Route Request and add this routing information to its Route Cache, subject to the conditions identified in Section 3.3.1. The routing information from the Route Request is the sequence of hop addresses

initiator, Address[1], Address[2], ..., Address[n]

where initiator is the value of the Source Address field in the IP header of the packet carrying the Route Request (the address of the initiator of the Route Discovery), and each Address[i] is a node through which this Route Request has passed, in turn, during

this Route Discovery. The value n , here, is the number of addresses recorded in the Route Request option, or $(\text{Opt Data Len} - 6) / 4$.

After possibly updating the node's Route Cache in response to the routing information in the Route Request option, the node MUST then process the Route Request option as described in Section 8.2.2.

- If the DSR Options header contains a Route Reply option, the node SHOULD extract the source route from the Route Reply and add this routing information to its Route Cache, subject to the conditions identified in Section 3.3.1. The source route from the Route Reply is the sequence of hop addresses

initiator, Address[1], Address[2], ..., Address[n]

where initiator is the value of the Destination Address field in the IP header of the packet carrying the Route Reply (the address of the initiator of the Route Discovery), and each Address[i] is a node through which the source route passes, in turn, on the route to the target of the Route Discovery. Address[n] is the address of the target. If the Last Hop External (L) bit is set in the Route Reply, the node MUST flag the last hop from the Route Reply (the link from Address[n-1] to Address[n]) in its Route Cache as External. The value n here is the number of addresses in the source route being returned in the Route Reply option, or $(\text{Opt Data Len} - 1) / 4$.

After possibly updating the node's Route Cache in response to the routing information in the Route Reply option, then if the packet's IP Destination Address matches one of this node's IP addresses, the node MUST then process the Route Reply option as described in Section 8.2.6.

- If the DSR Options header contains a Route Error option, the node MUST process the Route Error option as described in Section 8.3.5.
- If the DSR Options header contains an Acknowledgement Request option, the node MUST process the Acknowledgement Request option as described in Section 8.3.3.
- If the DSR Options header contains an Acknowledgement option, then subject to the conditions identified in Section 3.3.1, the node SHOULD add to its Route Cache the single link from the node identified by the ACK Source Address field to the node identified by the ACK Destination Address field.

After possibly updating the node's Route Cache in response to the routing information in the Acknowledgement option, the node MUST then process the Acknowledgement option as described in Section 8.3.3.

- If the DSR Options header contains a DSR Source Route option, the node SHOULD extract the source route from the DSR Source Route option and add this routing information to its Route Cache, subject to the conditions identified in Section 3.3.1. If the value of the Salvage field in the DSR Source Route option is zero, then the routing information from the DSR Source Route is the sequence of hop addresses

source, Address[1], Address[2], ..., Address[n], destination

Otherwise (i.e., if Salvage is nonzero), the routing information from the DSR Source Route is the sequence of hop addresses

Address[1], Address[2], ..., Address[n], destination

where source is the value of the Source Address field in the IP header of the packet carrying the DSR Source Route option (the original sender of the packet), each Address[i] is the value in the Address[i] field in the DSR Source Route option, and destination is the value of the Destination Address field in the packet's IP header (the last-hop address of the source route). The value n here is the number of addresses in source route in the DSR Source Route option, or $(\text{Opt Data Len} - 2) / 4$.

After possibly updating the node's Route Cache in response to the routing information in the DSR Source Route option, the node MUST then process the DSR Source Route option as described in Section 8.1.5.

- Any Pad1 or PadN options in the DSR Options header are ignored.
- Finally, if the Destination Address in the packet's IP header matches one of this receiving node's own IP address(es), remove the DSR Options header and all the included DSR options in the header, and pass the rest of the packet to the network layer.

8.1.5. Processing a Received DSR Source Route Option

When a node receives a packet containing a DSR Source Route option (whether for forwarding, overheard, or the final destination of the packet), that node SHOULD examine the packet to determine if the receipt of that packet indicates an opportunity for automatic route shortening, as described in Section 3.4.3. Specifically, if this

node is not the intended next-hop destination for the packet but is named in the later unexpended portion of the source route in the packet's DSR Source Route option, then this packet indicates an opportunity for automatic route shortening: the intermediate nodes after the node from which this node overheard the packet and before this node itself are no longer necessary in the source route. In this case, this node SHOULD perform the following sequence of steps as part of automatic route shortening:

- The node searches its Gratuitous Route Reply Table for an entry describing a gratuitous Route Reply earlier sent by this node, for which the original sender (of the packet triggering the gratuitous Route Reply) and the transmitting node (from which this node overheard that packet in order to trigger the gratuitous Route Reply) both match the respective node addresses for this new received packet. If such an entry is found in the node's Gratuitous Route Reply Table, the node SHOULD NOT perform automatic route shortening in response to this receipt of this packet.
- Otherwise, the node creates an entry for this overheard packet in its Gratuitous Route Reply Table. The timeout value for this new entry SHOULD be initialized to the value GratReplyHoldoff. After this timeout has expired, the node SHOULD delete this entry from its Gratuitous Route Reply Table.
- After creating the new Gratuitous Route Reply Table entry above, the node originates a gratuitous Route Reply to the IP Source Address of this overheard packet, as described in Section 3.4.3.

If the MAC protocol in use in the network is not capable of transmitting unicast packets over unidirectional links, as discussed in Section 3.3.1, then in originating this Route Reply, the node MUST use a source route for routing the Route Reply packet that is obtained by reversing the sequence of hops over which the packet triggering the gratuitous Route Reply was routed in reaching and being overheard by this node. This reversing of the route uses the gratuitous Route Reply to test this sequence of hops for bidirectionality, preventing the gratuitous Route Reply from being received by the initiator of the Route Discovery unless each of the hops over which the gratuitous Route Reply is returned is bidirectional.

- Discard the overheard packet, since the packet has been received before its normal traversal of the packet's source route would have caused it to reach this receiving node. Another copy of the packet will normally arrive at this node as indicated in the

packet's source route; discarding this initial copy of the packet, which triggered the gratuitous Route Reply, will prevent the duplication of this packet that would otherwise occur.

If the packet is not discarded as part of automatic route shortening above, then the node MUST process the Source Route option according to the following sequence of steps:

- If the value of the Segments Left field in the DSR Source Route option equals 0, then remove the DSR Source Route option from the DSR Options header.
- Else, let n equal $(\text{Opt Data Len} - 2) / 4$. This is the number of addresses in the DSR Source Route option.
- If the value of the Segments Left field is greater than n , then send an ICMP Parameter Problem, Code 0, message [RFC792] to the IP Source Address, pointing to the Segments Left field, and discard the packet. Do not process the DSR Source Route option further.
- Else, decrement the value of the Segments Left field by 1. Let i equal n minus Segments Left. This is the index of the next address to be visited in the Address vector.
- If Address[i] or the IP Destination Address is a multicast address, then discard the packet. Do not process the DSR Source Route option further.
- If this node has more than one network interface and if Address[i] is the address of one this node's network interfaces, then this indicates a change in the network interface to use in forwarding the packet, as described in Section 8.4. In this case, decrement the value of the Segments Left field by 1 to skip over this address (that indicated the change of network interface) and go to the first step above (checking the value of the Segments Left field) to continue processing this Source Route option; in further processing of this Source Route option, the indicated new network interface MUST be used in forwarding the packet.
- If the MTU of the link over which this node would transmit the packet to forward it to the node Address[i] is less than the size of the packet, the node MUST either discard the packet and send an ICMP Packet Too Big message to the packet's Source Address [RFC792] or fragment it as specified in Section 8.5.
- Forward the packet to the IP address specified in the Address[i] field of the IP header, following normal IP forwarding procedures, including checking and decrementing the Time-to-Live (TTL) field

in the packet's IP header [RFC791, RFC1122]. In this forwarding of the packet, the next-hop node (identified by Address[i]) MUST be treated as a direct neighbor node: the transmission to that next node MUST be done in a single IP forwarding hop, without Route Discovery and without searching the Route Cache.

- In forwarding the packet, perform Route Maintenance for the next hop of the packet, by verifying that the next-hop node is reachable, as described in Section 8.3.

Multicast addresses MUST NOT appear in a DSR Source Route option or in the IP Destination Address field of a packet carrying a DSR Source Route option in a DSR Options header.

8.1.6. Handling an Unknown DSR Option

Nodes implementing DSR MUST handle all options specified in this document, except those options pertaining to the optional flow state extension (Section 7). However, further extensions to DSR may include other option types that may not be understood by implementations conforming to this version of the DSR specification. In DSR, Option Type codes encode required behavior for nodes not implementing that type of option. These behaviors are included in the most significant 3 bits of the Option Type.

If the most significant bit of the Option Type is set (that is, Option Type & 0x80 is nonzero), and this packet does not contain a Route Request option, a node SHOULD return a Route Error to the IP Source Address, following the steps described in Section 8.3.4, except that the Error Type MUST be set to OPTION_NOT_SUPPORTED and the Unsupported Opt field MUST be set to the Option Type triggering the Route Error.

Whether or not a Route Error is sent in response to this DSR option, as described above, the node also MUST examine the next 2 most significant bits (that is, Option Type & 0x60):

- When these 2 bits are 00 (that is, Option Type & 0x60 == 0), a node not implementing processing for that Option Type MUST use the Opt Data Len field to skip over the option and continue processing.
- When these 2 bits are 01 (that is, Option Type & 0x60 == 0x20), a node not implementing processing for that Option Type MUST use the Opt Data Len field to remove the option from the packet and continue processing as if the option had not been included in the received packet.

- When these 2 bits are 10 (that is, Option Type & 0x60 == 0x40), a node not implementing processing for that Option Type MUST set the most significant bit following the Opt Data Len field. In addition, the node MUST then ignore and skip over the contents of the option using the Opt Data Len field and MUST continue processing the packet.
- Finally, when these 2 bits are 11 (that is, Option Type & 0x60 == 0x60), a node not implementing processing for that Option Type MUST drop the packet.

8.2. Route Discovery Processing

Route Discovery is the mechanism by which a node S wishing to send a packet to a destination node D obtains a source route to D. Route Discovery SHOULD be used only when S attempts to send a packet to D and does not already know a route to D. The node initiating a Route Discovery is known as the "initiator" of the Route Discovery, and the destination node for which the Route Discovery is initiated is known as the "target" of the Route Discovery.

Route Discovery operates entirely on demand; a node initiates Route Discovery based on its own origination of new packets for some destination address to which it does not currently know a route. Route Discovery does not depend on any periodic or background exchange of routing information or neighbor node detection at any layer in the network protocol stack at any node.

The Route Discovery procedure utilizes two types of messages, a Route Request (Section 6.2) and a Route Reply (Section 6.3), to actively search the ad hoc network for a route to the desired target destination. These DSR messages MAY be carried in any type of IP packet, through use of the DSR Options header as described in Section 6.

Except as discussed in Section 8.3.5, a Route Discovery for a destination address SHOULD NOT be initiated unless the initiating node has a packet in its Send Buffer requiring delivery to that destination. A Route Discovery for a given target node MUST NOT be initiated unless permitted by the rate-limiting information contained in the Route Request Table. After each Route Discovery attempt, the interval between successive Route Discoveries for this target SHOULD be doubled, up to a maximum of MaxRequestPeriod, until a valid Route Reply is received for this target.

8.2.1. Originating a Route Request

A node initiating a Route Discovery for some target creates and initializes a Route Request option in a DSR Options header in some IP packet. This MAY be a separate IP packet, used only to carry this Route Request option, or the node MAY include the Route Request option in some existing packet that it needs to send to the target node (e.g., the IP packet originated by this node that caused the node to attempt Route Discovery for the destination address of the packet). The Route Request option MUST be included in a DSR Options header in the packet. To initialize the Route Request option, the node performs the following sequence of steps:

- The Option Type in the option MUST be set to the value 2.
- The Opt Data Len field in the option MUST be set to the value 6. The total size of the Route Request option, when initiated, is 8 octets; the Opt Data Len field excludes the size of the Option Type and Opt Data Len fields themselves.
- The Identification field in the option MUST be set to a new value, different from that used for other Route Requests recently initiated by this node for this same target address. For example, each node MAY maintain a single counter value for generating a new Identification value for each Route Request it initiates.
- The Target Address field in the option MUST be set to the IP address that is the target of this Route Discovery.

The Source Address in the IP header of this packet MUST be the node's own IP address. The Destination Address in the IP header of this packet MUST be the IP "limited broadcast" address (255.255.255.255).

A node MUST maintain, in its Route Request Table, information about Route Requests that it initiates. When initiating a new Route Request, the node MUST use the information recorded in the Route Request Table entry for the target of that Route Request, and it MUST update that information in the table entry for use in the next Route Request initiated for this target. In particular:

- The Route Request Table entry for a target node records the Time-to-Live (TTL) field used in the IP header of the Route Request for the last Route Discovery initiated by this node for that target node. This value allows the node to implement a variety of algorithms for controlling the spread of its Route Request on each Route Discovery initiated for a target. As examples, two possible algorithms for this use of the TTL field are described in Section 3.3.3.

- The Route Request Table entry for a target node records the number of consecutive Route Requests initiated for this target since receiving a valid Route Reply giving a route to that target node, and the remaining amount of time before which this node MAY next attempt at a Route Discovery for that target node.

A node MUST use these values to implement a back-off algorithm to limit the rate at which this node initiates new Route Discoveries for the same target address. In particular, until a valid Route Reply is received for this target node address, the timeout between consecutive Route Discovery initiations for this target node with the same hop limit SHOULD increase by doubling the timeout value on each new initiation.

The behavior of a node processing a packet containing DSR Options header with both a DSR Source Route option and a Route Request option is unspecified. Packets SHOULD NOT contain both a DSR Source Route option and a Route Request option.

Packets containing a Route Request option SHOULD NOT include an Acknowledgement Request option, SHOULD NOT expect link-layer acknowledgement or passive acknowledgement, and SHOULD NOT be retransmitted. The retransmission of packets containing a Route Request option is controlled solely by the logic described in this section.

8.2.2. Processing a Received Route Request Option

When a node receives a packet containing a Route Request option, that node MUST process the option according to the following sequence of steps:

- If the Target Address field in the Route Request matches this node's own IP address, then the node SHOULD return a Route Reply to the initiator of this Route Request (the Source Address in the IP header of the packet), as described in Section 8.2.4. The source route for this Reply is the sequence of hop addresses

initiator, Address[1], Address[2], ..., Address[n], target

where initiator is the address of the initiator of this Route Request, each Address[i] is an address from the Route Request, and target is the target of the Route Request (the Target Address field in the Route Request). The value n here is the number of addresses recorded in the Route Request, or $(\text{Opt Data Len} - 6) / 4$.

The node then MUST replace the Destination Address field in the Route Request packet's IP header with the value in the Target Address field in the Route Request option, and continue processing the rest of the Route Request packet normally. The node MUST NOT process the Route Request option further and MUST NOT retransmit the Route Request to propagate it to other nodes as part of the Route Discovery.

- Else, the node MUST examine the route recorded in the Route Request option (the IP Source Address field and the sequence of Address[i] fields) to determine if this node's own IP address already appears in this list of addresses. If so, the node MUST discard the entire packet carrying the Route Request option.
- Else, if the Route Request was received through a network interface that requires physically bidirectional links for unicast transmission, the node MUST check if the Route Request was last forwarded by a node on its blacklist (Section 4.6). If such an entry is found in the blacklist, and the state of the unidirectional link is "probable", then the Request MUST be silently discarded.
- Else, if the Route Request was received through a network interface that requires physically bidirectional links for unicast transmission, the node MUST check if the Route Request was last forwarded by a node on its blacklist. If such an entry is found in the blacklist, and the state of the unidirectional link is "questionable", then the node MUST create and unicast a Route Request packet to that previous node, setting the IP Time-To-Live (TTL) to 1 to prevent the Request from being propagated. If the node receives a Route Reply in response to the new Request, it MUST remove the blacklist entry for that node, and SHOULD continue processing. If the node does not receive a Route Reply within some reasonable amount of time, the node MUST silently discard the Route Request packet.
- Else, the node MUST search its Route Request Table for an entry for the initiator of this Route Request (the IP Source Address field). If such an entry is found in the table, the node MUST search the cache of Identification values of recently received Route Requests in that table entry, to determine if an entry is present in the cache matching the Identification value and target node address in this Route Request. If such an (Identification, target address) entry is found in this cache in this entry in the Route Request Table, then the node MUST discard the entire packet carrying the Route Request option.

- Else, this node SHOULD further process the Route Request according to the following sequence of steps:
 - o Add an entry for this Route Request in its cache of (Identification, target address) values of recently received Route Requests.
 - o Conceptually create a copy of this entire packet and perform the following steps on the copy of the packet.
 - o Append this node's own IP address to the list of Address[i] values in the Route Request and increase the value of the Opt Data Len field in the Route Request by 4 (the size of an IP address). However, if the node has multiple network interfaces, this step MUST be modified by the special processing specified in Section 8.4.
 - o This node SHOULD search its own Route Cache for a route (from itself, as if it were the source of a packet) to the target of this Route Request. If such a route is found in its Route Cache, then this node SHOULD follow the procedure outlined in Section 8.2.3 to return a "cached Route Reply" to the initiator of this Route Request, if permitted by the restrictions specified there.
 - o If the node does not return a cached Route Reply, then this node SHOULD transmit this copy of the packet as a link-layer broadcast, with a short jitter delay before the broadcast is sent. The jitter period SHOULD be chosen as a random period, uniformly distributed between 0 and BroadcastJitter.

8.2.3. Generating a Route Reply Using the Route Cache

As described in Section 3.3.2, it is possible for a node processing a received Route Request to avoid propagating the Route Request further toward the target of the Request, if this node has in its Route Cache a route from itself to this target. Such a Route Reply generated by a node from its own cached route to the target of a Route Request is called a "cached Route Reply", and this mechanism can greatly reduce the overall overhead of Route Discovery on the network by reducing the flood of Route Requests. The general processing of a received Route Request is described in Section 8.2.2; this section specifies the additional requirements that MUST be met before a cached Route Reply may be generated and returned and specifies the procedure for returning such a cached Route Reply.

While processing a received Route Request, for a node to possibly return a cached Route Reply, it MUST have in its Route Cache a route from itself to the target of this Route Request. However, before generating a cached Route Reply for this Route Request, the node MUST verify that there are no duplicate addresses listed in the route accumulated in the Route Request together with the route from this node's Route Cache. Specifically, there MUST be no duplicates among the following addresses:

- The IP Source Address of the packet containing the Route Request,
- The Address[i] fields in the Route Request, and
- The nodes listed in the route obtained from this node's Route Cache, excluding the address of this node itself (this node itself is the common point between the route accumulated in the Route Request and the route obtained from the Route Cache).

If any duplicates exist among these addresses, then the node MUST NOT send a cached Route Reply using this route from the Route Cache (it is possible that this node has another route in its Route Cache for which the above restriction on duplicate addresses is met, allowing the node to send a cached Route Reply based on that cached route, instead). The node SHOULD continue to process the Route Request as described in Section 8.2.2 if it does not send a cached Route Reply.

If the Route Request and the route from the Route Cache meet the restriction above, then the node SHOULD construct and return a cached Route Reply as follows:

- The source route for this Route Reply is the sequence of hop addresses

initiator, Address[1], Address[2], ..., Address[n], c-route

where initiator is the address of the initiator of this Route Request, each Address[i] is an address from the Route Request, and c-route is the sequence of hop addresses in the source route to this target node, obtained from the node's Route Cache. In appending this cached route to the source route for the reply, the address of this node itself MUST be excluded, since it is already listed as Address[n].

- Send a Route Reply to the initiator of the Route Request, using the procedure defined in Section 8.2.4. The initiator of the Route Request is indicated in the Source Address field in the packet's IP header.

Before sending the cached Route Reply, however, the node MAY delay the Reply in order to help prevent a possible Route Reply "storm", as described in Section 8.2.5.

If the node returns a cached Route Reply as described above, then the node MUST NOT propagate the Route Request further (i.e., the node MUST NOT rebroadcast the Route Request). In this case, instead, if the packet contains no other DSR options and contains no payload after the DSR Options header (e.g., the Route Request is not piggybacked on a TCP or UDP packet), then the node SHOULD simply discard the packet. Otherwise (if the packet contains other DSR options or contains any payload after the DSR Options header), the node SHOULD forward the packet along the cached route to the target of the Route Request. Specifically, if the node does so, it MUST use the following steps:

- Copy the Target Address from the Route Request option in the DSR Options header to the Destination Address field in the packet's IP header.
- Remove the Route Request option from the DSR Options header in the packet, and add a DSR Source Route option to the packet's DSR Options header.
- In the DSR Source Route option, set the Address[i] fields to represent the source route found in this node's Route Cache to the original target of the Route Discovery (the new IP Destination Address of the packet). Specifically, the node copies the hop addresses of the source route into sequential Address[i] fields in the DSR Source Route option, for $i = 1, 2, \dots, n$. Address[1], here, is the address of this node itself (the first address in the source route found from this node to the original target of the Route Discovery). The value n , here, is the number of hop addresses in this source route, excluding the destination of the packet (which is instead already represented in the Destination Address field in the packet's IP header).
- Initialize the Segments Left field in the DSR Source Route option to n as defined above.
- The First Hop External (F) bit in the DSR Source Route option MUST be set to 0.
- The Last Hop External (L) bit in the DSR Source Route option is copied from the External bit flagging the last hop in the source route for the packet, as indicated in the Route Cache.

- The Salvage field in the DSR Source Route option MUST be initialized to some nonzero value; the particular nonzero value used SHOULD be MAX_SALVAGE_COUNT. By initializing this field to a nonzero value, nodes forwarding or overhearing this packet will not consider a link to exist between the IP Source Address of the packet and the Address[1] address in the DSR Source Route option (e.g., they will not attempt to add this to their Route Cache as a link). By choosing MAX_SALVAGE_COUNT as the nonzero value to which the node initializes this field, nodes furthermore will not attempt to salvage this packet.
- Transmit the packet to the next-hop node on the new source route in the packet, using the forwarding procedure described in Section 8.1.5.

8.2.4. Originating a Route Reply

A node originates a Route Reply in order to reply to a received and processed Route Request, according to the procedures described in Sections 8.2.2 and 8.2.3. The Route Reply is returned in a Route Reply option (Section 6.3). The Route Reply option MAY be returned to the initiator of the Route Request in a separate IP packet, used only to carry this Route Reply option, or it MAY be included in any other IP packet being sent to this address.

The Route Reply option MUST be included in a DSR Options header in the packet returned to the initiator. To initialize the Route Reply option, the node performs the following sequence of steps:

- The Option Type in the option MUST be set to the value 3.
- The Opt Data Len field in the option MUST be set to the value $(n * 4) + 3$, where n is the number of addresses in the source route being returned (excluding the Route Discovery initiator node's address).
- If this node is the target of the Route Request, the Last Hop External (L) bit in the option MUST be initialized to 0.
- The Reserved field in the option MUST be initialized to 0.
- The Route Request Identifier MUST be initialized to the Identifier field of the Route Request to which this Route Reply is sent in response.
- The sequence of hop addresses in the source route are copied into the Address[i] fields of the option. Address[1] MUST be set to the first-hop address of the route after the initiator of the

Route Discovery, Address[n] MUST be set to the last-hop address of the source route (the address of the target node), and each other Address[i] MUST be set to the next address in sequence in the source route being returned.

The Destination Address field in the IP header of the packet carrying the Route Reply option MUST be set to the address of the initiator of the Route Discovery (i.e., for a Route Reply being returned in response to some Route Request, the IP Source Address of the Route Request).

After creating and initializing the Route Reply option and the IP packet containing it, send the Route Reply. In sending the Route Reply from this node (but not from nodes forwarding the Route Reply), this node SHOULD delay the Reply by a small jitter period chosen randomly between 0 and BroadcastJitter.

When returning any Route Reply in the case in which the MAC protocol in use in the network is not capable of transmitting unicast packets over unidirectional links, the source route used for routing the Route Reply packet MUST be obtained by reversing the sequence of hops in the Route Request packet (the source route that is then returned in the Route Reply). This restriction on returning a Route Reply enables the Route Reply to test this sequence of hops for bidirectionality, preventing the Route Reply from being received by the initiator of the Route Discovery unless each of the hops over which the Route Reply is returned (and thus each of the hops in the source route being returned in the Reply) is bidirectional.

If sending a Route Reply to the initiator of the Route Request requires performing a Route Discovery, the Route Reply option MUST be piggybacked on the packet that contains the Route Request. This piggybacking prevents a recursive dependency wherein the target of the new Route Request (which was itself the initiator of the original Route Request) must do another Route Request in order to return its Route Reply.

If sending the Route Reply to the initiator of the Route Request does not require performing a Route Discovery, a node SHOULD send a unicast Route Reply in response to every Route Request it receives for which it is the target node.

8.2.5. Preventing Route Reply Storms

The ability for nodes to reply to a Route Request based on information in their Route Caches, as described in Sections 3.3.2 and 8.2.3, could result in a possible Route Reply "storm" in some cases. In particular, if a node broadcasts a Route Request for a target node

for which the node's neighbors have a route in their Route Caches, each neighbor may attempt to send a Route Reply, thereby wasting bandwidth and possibly increasing the number of network collisions in the area.

For example, the figure below shows a situation in which nodes B, C, D, E, and F all receive A's Route Request for target G, and each has the indicated route cached for this target:

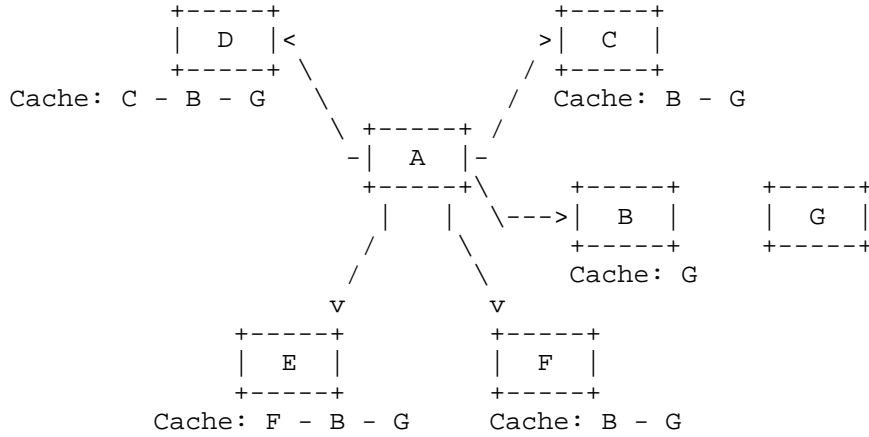

Normally, each of these nodes would attempt to reply from its own Route Cache, and they would thus all send their Route Replies at about the same time, since they all received the broadcast Route Request at about the same time. Such simultaneous Route Replies from different nodes all receiving the Route Request may cause local congestion in the wireless network and may create packet collisions among some or all of these Replies if the MAC protocol in use does not provide sufficient collision avoidance for these packets. In addition, it will often be the case that the different replies will indicate routes of different lengths, as shown in this example.

In order to reduce these effects, if a node can put its network interface into promiscuous receive mode, it MAY delay sending its own Route Reply for a short period, while listening to see if the initiating node begins using a shorter route first. Specifically, this node MAY delay sending its own Route Reply for a random period

$$d = H * (h - 1 + r)$$

where h is the length in number of network hops for the route to be returned in this node's Route Reply, r is a random floating point number between 0 and 1, and H is a small constant delay (at least twice the maximum wireless link propagation delay) to be introduced

per hop. This delay effectively randomizes the time at which each node sends its Route Reply, with all nodes sending Route Replies giving routes of length less than h sending their Replies before this node, and all nodes sending Route Replies giving routes of length greater than h send their Replies after this node.

Within the delay period, this node promiscuously receives all packets, looking for data packets from the initiator of this Route Discovery destined for the target of the Route Discovery. If such a data packet received by this node during the delay period uses a source route of length less than or equal to h , this node may infer that the initiator of the Route Discovery has already received a Route Reply giving an equally good or better route. In this case, this node SHOULD cancel its delay timer and SHOULD NOT send its Route Reply for this Route Discovery.

8.2.6. Processing a Received Route Reply Option

Section 8.1.4 describes the general processing for a received packet, including the addition of routing information from options in the packet's DSR Options header to the receiving node's Route Cache.

If the received packet contains a Route Reply, no additional special processing of the Route Reply option is required beyond what is described there. As described in Section 4.1, anytime a node adds new information to its Route Cache (including the information added from this Route Reply option), the node SHOULD check each packet in its own Send Buffer (Section 4.2) to determine whether a route to that packet's IP Destination Address now exists in the node's Route Cache (including the information just added to the Cache). If so, the packet SHOULD then be sent using that route and removed from the Send Buffer. This general procedure handles all processing required for a received Route Reply option.

When using a MAC protocol that requires bidirectional links for unicast transmission, a unidirectional link may be discovered by the propagation of the Route Request. When the Route Reply is sent over the reverse path, a forwarding node may discover that the next-hop is unreachable. In this case, it MUST add the next-hop address to its blacklist (Section 4.6).

8.3. Route Maintenance Processing

Route Maintenance is the mechanism by which a source node S is able to detect, while using a source route to some destination node D , if the network topology has changed such that it can no longer use its route to D because a link along the route no longer works. When Route Maintenance indicates that a source route is broken, S can

attempt to use any other route it happens to know to D or can invoke Route Discovery again to find a new route for subsequent packets to D. Route Maintenance for this route is used only when S is actually sending packets to D.

Specifically, when forwarding a packet, a node MUST attempt to confirm the reachability of the next-hop node, unless such confirmation had been received in the last MaintHoldoffTime period. Individual implementations MAY choose to bypass such confirmation for some limited number of packets, as long as those packets all fall within MaintHoldoffTime since the last confirmation. If no confirmation is received after the retransmission of MaxMaintRexmt acknowledgement requests, after the initial transmission of the packet, and conceptually including all retransmissions provided by the MAC layer, the node determines that the link for this next-hop node of the source route is "broken". This confirmation from the next-hop node for Route Maintenance can be implemented using a link-layer acknowledgement (Section 8.3.1), a "passive acknowledgement" (Section 8.3.2), or a network-layer acknowledgement (Section 8.3.3); the particular strategy for retransmission timing depends on the type of acknowledgement mechanism used. When not using link-layer acknowledgements for Route Maintenance, nodes SHOULD use passive acknowledgements when possible but SHOULD try requesting a network-layer acknowledgement one or more times before deciding that the link has failed and originating a Route Error to the original sender of the packet, as described in Section 8.3.4.

In deciding whether or not to send a Route Error in response to attempting to forward a packet from some sender over a broken link, a node MUST limit the number of consecutive packets from a single sender that the node attempts to forward over this same broken link for which the node chooses not to return a Route Error. This requirement MAY be satisfied by returning a Route Error for each packet that the node attempts to forward over a broken link.

8.3.1. Using Link-Layer Acknowledgements

If the MAC protocol in use provides feedback as to the successful delivery of a data packet (such as is provided for unicast packets by the link-layer acknowledgement frame defined by IEEE 802.11 [IEEE80211]), then the use of the DSR Acknowledgement Request and Acknowledgement options is not necessary. If such link-layer feedback is available, it SHOULD be used instead of any other acknowledgement mechanism for Route Maintenance, and the node SHOULD NOT use either passive acknowledgements or network-layer acknowledgements for Route Maintenance.

When using link-layer acknowledgements for Route Maintenance, the retransmission timing and the timing at which retransmission attempts are scheduled are generally controlled by the particular link layer implementation in use in the network. For example, in IEEE 802.11, the link-layer acknowledgement is returned after a unicast packet as a part of the basic access method of the IEEE 802.11 Distributed Coordination Function (DCF) MAC protocol; the time at which the acknowledgement is expected to arrive and the time at which the next retransmission attempt (if necessary) will occur are controlled by the MAC protocol implementation.

When a node receives a link-layer acknowledgement for any packet in its Maintenance Buffer, that node SHOULD remove from its Maintenance Buffer that packet, as well as any other packets in its Maintenance Buffer with the same next-hop destination.

8.3.2. Using Passive Acknowledgements

When link-layer acknowledgements are not available, but passive acknowledgements [JUBIN87] are available, passive acknowledgements SHOULD be used for Route Maintenance when originating or forwarding a packet along any hop other than the last hop (the hop leading to the IP Destination Address node of the packet). In particular, passive acknowledgements SHOULD be used for Route Maintenance in such cases if the node can place its network interface into "promiscuous" receive mode, and if network links used for data packets generally operate bidirectionally.

A node MUST NOT attempt to use passive acknowledgements for Route Maintenance for a packet originated or forwarded over its last hop (the hop leading to the IP Destination Address node of the packet), since the receiving node will not be forwarding the packet and thus no passive acknowledgement will be available to be heard by this node. Beyond this restriction, a node MAY utilize a variety of strategies in using passive acknowledgements for Route Maintenance of a packet that it originates or forwards. For example, the following two strategies are possible:

- Each time a node receives a packet to be forwarded to a node other than the final destination (the IP Destination Address of the packet), that node sends the original transmission of that packet without requesting a network-layer acknowledgement for it. If no passive acknowledgement is received within PassiveAckTimeout after this transmission, the node retransmits the packet, again without requesting a network-layer acknowledgement for it; the same PassiveAckTimeout timeout value is used for each such attempt. If no acknowledgement has been received after a total of TryPassiveAcks retransmissions of the packet, network-layer

acknowledgements (as described in Section 8.3.3) are requested for all remaining attempts for that packet.

- Each node maintains a table of possible next-hop destination nodes, noting whether or not passive acknowledgements can typically be expected from transmission to that node, and the expected latency and jitter of a passive acknowledgement from that node. Each time a node receives a packet to be forwarded to a node other than the IP Destination Address, the node checks its table of next-hop destination nodes to determine whether to use a passive acknowledgement or a network-layer acknowledgement for that transmission to that node. The timeout for this packet can also be derived from this table. A node using this method SHOULD prefer using passive acknowledgements to network-layer acknowledgements.

In using passive acknowledgements for a packet that it originates or forwards, a node considers the later receipt of a new packet (e.g., with promiscuous receive mode enabled on its network interface) an acknowledgement of this first packet if both of the following two tests succeed:

- The Source Address, Destination Address, Protocol, Identification, and Fragment Offset fields in the IP header of the two packets MUST match [RFC791].
- If either packet contains a DSR Source Route header, both packets MUST contain one, and the value in the Segments Left field in the DSR Source Route header of the new packet MUST be less than that in the first packet.

When a node hears such a passive acknowledgement for any packet in its Maintenance Buffer, that node SHOULD remove from its Maintenance Buffer that packet, as well as any other packets in its Maintenance Buffer with the same next-hop destination.

8.3.3. Using Network-Layer Acknowledgements

When a node originates or forwards a packet and has no other mechanism of acknowledgement available to determine reachability of the next-hop node in the source route for Route Maintenance, that node SHOULD request a network-layer acknowledgement from that next-hop node. To do so, the node inserts an Acknowledgement Request option in the DSR Options header in the packet. The Identification field in that Acknowledgement Request option MUST be set to a value unique over all packets recently transmitted by this node to the same next-hop node.

When a node receives a packet containing an Acknowledgement Request option, that node performs the following tests on the packet:

- If the indicated next-hop node address for this packet does not match any of this node's own IP addresses, then this node MUST NOT process the Acknowledgement Request option. The indicated next-hop node address is the next Address[i] field in the DSR Source Route option in the DSR Options header in the packet, or the IP Destination Address in the packet if the packet does not contain a DSR Source Route option or the Segments Left there is zero.
- If the packet contains an Acknowledgement option, then this node MUST NOT process the Acknowledgement Request option.

If neither of the tests above fails, then this node MUST process the Acknowledgement Request option by sending an Acknowledgement option to the previous-hop node; to do so, the node performs the following sequence of steps:

- Create a packet and set the IP Protocol field to the protocol number assigned for DSR (48).
- Set the IP Source Address field in this packet to the IP address of this node, copied from the source route in the DSR Source Route option in that packet (or from the IP Destination Address field of the packet, if the packet does not contain a DSR Source Route option).
- Set the IP Destination Address field in this packet to the IP address of the previous-hop node, copied from the source route in the DSR Source Route option in that packet (or from the IP Source Address field of the packet, if the packet does not contain a DSR Source Route option).
- Add a DSR Options header to the packet. Set the Next Header field in the DSR Options header to the value 59, "No Next Header" [RFC2460].
- Add an Acknowledgement option to the DSR Options header in the packet; set the Acknowledgement option's Option Type field to 6 and the Opt Data Len field to 10.
- Copy the Identification field from the received Acknowledgement Request option into the Identification field in the Acknowledgement option.

- Set the ACK Source Address field in the Acknowledgement option to be the IP Source Address of this new packet (set above to be the IP address of this node).
- Set the ACK Destination Address field in the Acknowledgement option to be the IP Destination Address of this new packet (set above to be the IP address of the previous-hop node).
- Send the packet as described in Section 8.1.1.

Packets containing an Acknowledgement option SHOULD NOT be placed in the Maintenance Buffer.

When a node receives a packet with both an Acknowledgement option and an Acknowledgement Request option, if that node is not the destination of the Acknowledgement option (the IP Destination Address of the packet), then the Acknowledgement Request option MUST be ignored. Otherwise (that node is the destination of the Acknowledgement option), that node MUST process the Acknowledgement Request option by returning an Acknowledgement option according to the following sequence of steps:

- Create a packet and set the IP Protocol field to the protocol number assigned for DSR (48).
- Set the IP Source Address field in this packet to the IP address of this node, copied from the source route in the DSR Source Route option in that packet (or from the IP Destination Address field of the packet, if the packet does not contain a DSR Source Route option).
- Set the IP Destination Address field in this packet to the IP address of the node originating the Acknowledgement option.
- Add a DSR Options header to the packet, and set the DSR Options header's Next Header field to the value 59, "No Next Header" [RFC2460].
- Add an Acknowledgement option to the DSR Options header in this packet; set the Acknowledgement option's Option Type field to 6 and the Opt Data Len field to 10.
- Copy the Identification field from the received Acknowledgement Request option into the Identification field in the Acknowledgement option.

- Set the ACK Source Address field in the option to the IP Source Address of this new packet (set above to be the IP address of this node).
- Set the ACK Destination Address field in the option to the IP Destination Address of this new packet (set above to be the IP address of the node originating the Acknowledgement option).
- Send the packet directly to the destination. The IP Destination Address MUST be treated as a direct neighbor node: the transmission to that node MUST be done in a single IP forwarding hop, without Route Discovery and without searching the Route Cache. In addition, this packet MUST NOT contain a DSR Acknowledgement Request, MUST NOT be retransmitted for Route Maintenance, and MUST NOT expect a link-layer acknowledgement or passive acknowledgement.

When using network-layer acknowledgements for Route Maintenance, a node SHOULD use an adaptive algorithm in determining the retransmission timeout for each transmission attempt of an acknowledgement request. For example, a node SHOULD maintain a separate round-trip time (RTT) estimate for each node to which it has recently attempted to transmit packets, and it SHOULD use this RTT estimate in setting the timeout for each retransmission attempt for Route Maintenance. The TCP RTT estimation algorithm has been shown to work well for this purpose in implementation and testbed experiments with DSR [MALTZ99b, MALTZ01].

8.3.4. Originating a Route Error

When a node is unable to verify reachability of a next-hop node after reaching a maximum number of retransmission attempts, it SHOULD send a Route Error to the IP Source Address of the packet. When sending a Route Error for a packet containing either a Route Error option or an Acknowledgement option, a node SHOULD add these existing options to its Route Error, subject to the limit described below.

A node transmitting a Route Error MUST perform the following steps:

- Create an IP packet and set the IP Protocol field to the protocol number assigned for DSR (48). Set the Source Address field in this packet's IP header to the address of this node.
- If the Salvage field in the DSR Source Route option in the packet triggering the Route Error is zero, then copy the Source Address field of the packet triggering the Route Error into the Destination Address field in the new packet's IP header;

otherwise, copy the Address[1] field from the DSR Source Route option of the packet triggering the Route Error into the Destination Address field in the new packet's IP header

- Insert a DSR Options header into the new packet.
- Add a Route Error Option to the new packet, setting the Error Type to NODE_UNREACHABLE, the Salvage value to the Salvage value from the DSR Source Route option of the packet triggering the Route Error, and the Unreachable Node Address field to the address of the next-hop node from the original source route. Set the Error Source Address field to this node's IP address, and the Error Destination field to the new packet's IP Destination Address.
- If the packet triggering the Route Error contains any Route Error or Acknowledgement options, the node MAY append to its Route Error each of these options, with the following constraints:
 - o The node MUST NOT include any Route Error option from the packet triggering the new Route Error, for which the total Salvage count (Section 6.4) of that included Route Error would be greater than MAX_SALVAGE_COUNT in the new packet.
 - o If any Route Error option from the packet triggering the new Route Error is not included in the packet, the node MUST NOT include any following Route Error or Acknowledgement options from the packet triggering the new Route Error.
 - o Any appended options from the packet triggering the Route Error MUST follow the new Route Error in the packet.
 - o In appending these options to the new Route Error, the order of these options from the packet triggering the Route Error MUST be preserved.
- Send the packet as described in Section 8.1.1.

8.3.5. Processing a Received Route Error Option

When a node receives a packet containing a Route Error option, that node MUST process the Route Error option according to the following sequence of steps:

- The node MUST remove from its Route Cache the link from the node identified by the Error Source Address field to the node identified by the Unreachable Node Address field (if this link is present in its Route Cache). If the node implements its Route Cache as a link cache, as described in Section 4.1, only this

single link is removed; if the node implements its Route Cache as a path cache, however, all routes (paths) that use this link are either truncated before the link or removed completely.

- If the option following the Route Error is an Acknowledgement or Route Error option sent by this node (that is, with Acknowledgement or Error Source Address equal to this node's address), copy the DSR options following the current Route Error into a new packet with IP Source Address equal to this node's own IP address and IP Destination Address equal to the Acknowledgement or Error Destination Address. Transmit this packet as described in Section 8.1.1, with the Salvage count in the DSR Source Route option set to the Salvage value of the Route Error.

In addition, after processing the Route Error as described above, the node MAY initiate a new Route Discovery for any destination node for which it then has no route in its Route Cache as a result of processing this Route Error, if the node has indication that a route to that destination is needed. For example, if the node has an open TCP connection to some destination node, then if the processing of this Route Error removed the only route to that destination from this node's Route Cache, then this node MAY initiate a new Route Discovery for that destination node. Any node, however, MUST limit the rate at which it initiates new Route Discoveries for any single destination address, and any new Route Discovery initiated in this way as part of processing this Route Error MUST conform as a part of this limit.

8.3.6. Salvaging a Packet

When an intermediate node forwarding a packet detects through Route Maintenance that the next-hop link along the route for that packet is broken (Section 8.3), if the node has another route to the packet's IP Destination Address in its Route Cache, the node SHOULD "salvage" the packet rather than discard it. To do so using the route found in its Route Cache, this node processes the packet as follows:

- If the MAC protocol in use in the network is not capable of transmitting unicast packets over unidirectional links, as discussed in Section 3.3.1, then if this packet contains a Route Reply option, remove and discard the Route Reply option in the packet; if the DSR Options header in the packet then contains no DSR options or only a DSR Source Route Option, remove the DSR Options header from the packet. If the resulting packet then contains only an IP header (e.g., no transport layer header or payload), the node SHOULD NOT salvage the packet and instead SHOULD discard the entire packet.

- Modify the existing DSR Source Route option in the packet so that the Address[i] fields represent the source route found in this node's Route Cache to this packet's IP Destination Address. Specifically, the node copies the hop addresses of the source route into sequential Address[i] fields in the DSR Source Route option, for $i = 1, 2, \dots, n$. Address[1], here, is the address of the salvaging node itself (the first address in the source route found from this node to the IP Destination Address of the packet). The value n , here, is the number of hop addresses in this source route, excluding the destination of the packet (which is instead already represented in the Destination Address field in the packet's IP header).
- Initialize the Segments Left field in the DSR Source Route option to n as defined above.
- The First Hop External (F) bit in the DSR Source Route option MUST be set to 0.
- The Last Hop External (L) bit in the DSR Source Route option is copied from the External bit flagging the last hop in the source route for the packet, as indicated in the Route Cache.
- The Salvage field in the DSR Source Route option is set to 1 plus the value of the Salvage field in the DSR Source Route option of the packet that caused the error.
- Transmit the packet to the next-hop node on the new source route in the packet, using the forwarding procedure described in Section 8.1.5.

As described in Section 8.3.4, the node in this case also SHOULD return a Route Error to the original sender of the packet. If the node chooses to salvage the packet, it SHOULD do so after originating the Route Error.

When returning any Route Reply in the case in which the MAC protocol in use in the network is not capable of transmitting unicast packets over unidirectional links, the source route used for routing the Route Reply packet MUST be obtained by reversing the sequence of hops in the Route Request packet (the source route that is then returned in the Route Reply). This restriction on returning a Route Reply and on salvaging a packet that contains a Route Reply option enables the Route Reply to test this sequence of hops for bidirectionality, preventing the Route Reply from being received by the initiator of the Route Discovery unless each of the hops over which the Route Reply is returned (and thus each of the hops in the source route being returned in the Reply) is bidirectional.

8.4. Multiple Network Interface Support

A node using DSR MAY have multiple network interfaces that support DSR ad hoc network routing. This section describes special packet processing at such nodes.

A node with multiple network interfaces that support DSR ad hoc network routing MUST have some policy for determining which Route Request packets are forwarded using which network interfaces. For example, a node MAY choose to forward all Route Requests over all network interfaces.

When a node with multiple network interfaces that support DSR propagates a Route Request on a network interface other than the one on which it received the Route Request, it MUST in this special case modify the Address list in the Route Request as follows:

- Append the node's IP address for the incoming network interface.
- Append the node's IP address for the outgoing network interface.

When a node forwards a packet containing a source route, it MUST assume that the next-hop node is reachable on the incoming network interface, unless the next hop is the address of one of this node's network interfaces, in which case this node MUST skip over this address in the source route and process the packet in the same way as if it had just received it from that network interface, as described in Section 8.1.5.

If a node that previously had multiple network interfaces that support DSR receives a packet sent with a source route specifying a change to a network interface, as described above, that is no longer available, it MAY send a Route Error to the source of the packet without attempting to forward the packet on the incoming network interface, unless the network uses an autoconfiguration mechanism that may have allowed another node to acquire the now unused address of the unavailable network interface.

8.5. IP Fragmentation and Reassembly

When a node using DSR wishes to fragment a packet that contains a DSR header not containing a Route Request option, it MUST perform the following sequence of steps:

- Remove the DSR Options header from the packet.

- Fragment the packet using normal IP fragmentation processing [RFC791]. However, when determining the size of each fragment to create from the original packet, the fragment size MUST be reduced by the size of the DSR Options header from the original packet.
- IP-in-IP encapsulate each fragment [RFC2003]. The IP Destination address of the outer (encapsulating) packet MUST be set equal to the IP Destination address of the original packet.
- Add the DSR Options header from the original packet to each resulting encapsulating packet. If a Source Route header is present in the DSR Options header, increment the Salvage field.

When a node using the DSR protocol receives an IP-in-IP encapsulated packet destined to itself, it SHOULD decapsulate the packet [RFC2003] and then process the inner packet according to standard IP reassembly processing [RFC791].

8.6. Flow State Processing

A node implementing the optional DSR flow state extension MUST follow these additional processing steps.

8.6.1. Originating a Packet

When originating any packet to be routed using flow state, a node using DSR flow state MUST do the following:

- If the route to be used for this packet has never had a DSR flow state established along it (or the existing flow state has expired):
 - o Generate a 16-bit Flow ID larger than any unexpired Flow IDs used by this node for this destination. Odd Flow IDs MUST be chosen for "default" flows; even Flow IDs MUST be chosen for non-default flows.
 - o Add a DSR Options header, as described in Section 8.1.2.
 - o Add a DSR Flow State header, as described in Section 8.6.2.
 - o Initialize the Hop Count field in the DSR Flow State header to 0.
 - o Set the Flow ID field in the DSR Flow State header to the Flow ID generated in the first step.
 - o Add a Timeout option to the DSR Options header.

- o Add a Source Route option after the Timeout option with the route to be used, as described in Section 8.1.3.
- o The source node SHOULD record this flow in its Flow Table.
- o If this flow is recorded in the Flow Table, the TTL in this Flow Table entry MUST be set to be the TTL of this flow establishment packet.
- o If this flow is recorded in the Flow Table, the timeout in this Flow Table entry MUST be set to a value no less than the value specified in the Timeout option.
- If the route to be used for this packet has had DSR flow state established along it, but has not been established end-to-end:
 - o Add a DSR Options header, as described in Section 8.1.2.
 - o Add a DSR Flow State header, as described in Section 8.6.2.
 - o Initialize the Hop Count field in the DSR Flow State header to 0.
 - o The Flow ID field of the DSR Flow State header SHOULD be the Flow ID previously used for this route. If it is not, the steps for sending packets along never-before-established routes above MUST be followed in place of these.
 - o Add a Timeout option to the DSR Options header, setting the Timeout to a value not greater than the timeout remaining for this flow in the Flow Table.
 - o Add a Source Route option after the Timeout option with the route to be used, as described in Section 8.1.3.
 - o If the IP TTL is not equal to the TTL specified in the Flow Table, the source node MUST set a flag to indicate that this flow cannot be used as default.
- If the route the node wishes to use for this packet has been established as a flow end-to-end and is not the default flow:
 - o Add a DSR Flow State header, as described in Section 8.6.2.
 - o Initialize the Hop Count field in the DSR Flow State header to 0.

- o The Flow ID field of the DSR Flow State header SHOULD be set to the Flow ID previously used for this route. If it is not, the steps for sending packets along never-before-established routes above MUST be followed in place of these.
- o If the next hop requires a network-layer acknowledgement for Route Maintenance, add a DSR Options header, as described in Section 8.1.2, and an Acknowledgement Request option, as described in Section 8.3.3.
- o A DSR Options header SHOULD NOT be added to a packet, unless it is added to carry an Acknowledgement Request option, in which case:
 - + A Source Route option in the DSR Options header SHOULD NOT be added.
 - + If a Source Route option in the DSR Options header is added, the steps for sending packets along flows not yet established end-to-end MUST be followed in place of these.
 - + A Timeout option SHOULD NOT be added.
 - + If a Timeout option is added, it MUST specify a timeout not greater than the timeout remaining for this flow in the Flow Table.
- If the route the node wishes to use for this packet has been established as a flow end-to-end and is the current default flow:
 - o If the IP TTL is not equal to the TTL specified in the Flow Table, the source node MUST follow the steps above for sending a packet along a non-default flow that has been established end-to-end in place of these steps.
 - o If the next hop requires a network-layer acknowledgement for Route Maintenance, the sending node MUST add a DSR Options header and an Acknowledgement Request option, as described in Section 8.3.3. The sending node MUST NOT add any additional options to this header.
 - o A DSR Options header SHOULD NOT be added, except as specified in the previous step. If one is added in a way inconsistent with the previous step, the source node MUST follow the steps above for sending a packet along a non-default flow that has been established end-to-end in place of these steps.

8.6.2. Inserting a DSR Flow State Header

A node originating a packet adds a DSR Flow State header to the packet, if necessary, to carry information needed by the routing protocol. A packet MUST NOT contain more than one DSR Flow State header. A DSR Flow State header is added to a packet by performing the following sequence of steps:

- Insert a DSR Flow State header after the IP header and any Hop-by-Hop Options header that may already be in the packet, but before any other header that may be present.
- Set the Next Header field of the DSR Flow State header to the Next Header field of the previous header (either an IP header or a Hop-by-Hop Options header).
- Set the Flow (F) bit in the DSR Flow State header to 1.
- Set the Protocol field of the IP header to the protocol number assigned for DSR (48).

8.6.3. Receiving a Packet

This section describes processing only for packets that are sent to this processing node as the next-hop node; that is, when the MAC-layer destination address is the MAC address of this node. Otherwise, the process described in Sections 8.6.5 should be followed.

The flow along which a packet is being sent is considered to be in the Flow Table if the triple (IP Source Address, IP Destination Address, Flow ID) has an unexpired entry in this node's Flow Table.

When a node using DSR flow state receives a packet, it MUST follow the following steps for processing:

- If a DSR Flow State header is present, increment the Hop Count field.
- In addition, if a DSR Flow State header is present, then if the triple (IP Source Address, IP Destination Address, Flow ID) is in this node's Automatic Route Shortening Table and the packet is listed in the entry, then the node MAY send a gratuitous Route Reply as described in Section 4.4, subject to the rate limiting specified therein. This gratuitous Route Reply gives the route by which the packet originally reached this node. Specifically, the node sending the gratuitous Route Reply constructs the route to return in the Route Reply as follows:

- o Let $k = (\text{packet Hop Count}) - (\text{table Hop Count})$, where packet Hop Count is the value of the Hop Count field in this received packet, and table Hop Count is the Hop Count value stored for this packet in the corresponding entry in this node's Automatic Route Shortening Table.
 - o Copy the complete source route for this flow from the corresponding entry in the node's Flow Table.
 - o Remove from this route the k hops immediately preceding this node in the route, since these are the hops "skipped over" by the packet as recorded in the Automatic Route Shortening Table entry.
- Process each of the DSR options within the DSR Options header in order:
- o On receiving a Pad1 or PadN option, skip over the option.
 - o On receiving a Route Request for which this node is the destination, remove the option and return a Route Reply as specified in Section 8.2.2.
 - o On receiving a broadcast Route Request that this node has not previously seen for which this node is not the destination, append this node's incoming interface address to the Route Request, continue propagating the Route Request as specified in Section 8.2.2, pass the payload, if any, to the network layer, and stop processing.
 - o On receiving a Route Request that this node has previously seen for which this node is not the destination, discard the packet and stop processing.
 - o On receiving any Route Request, add appropriate links to the Route Cache, as specified in Section 8.2.2.
 - o On receiving a Route Reply for which this node is the initiator, remove the Route Reply from the packet and process it as specified in Section 8.2.6.
 - o On receiving any Route Reply, add appropriate links to the Route Cache, as specified in Section 8.2.6.
 - o On receiving any Route Error of type NODE_UNREACHABLE, remove appropriate links to the Route Cache, as specified in Section 8.3.5.

- o On receiving a Route Error of type `NODE_UNREACHABLE` that this node is the Error Destination Address of, remove the Route Error from the packet and process it as specified in Section 8.3.5. It also **MUST** stop originating packets along any flows using the link from Error Source Address to Unreachable Node, and it **MAY** remove from its Flow Table any flows using the link from Error Source Address to Unreachable Node.
- o On receiving a Route Error of type `UNKNOWN_FLOW` that this node is not the Error Destination Address of, the node checks if the Route Error corresponds to a flow in its Flow Table. If it does not, the node silently discards the Route Error; otherwise, it forwards the packet to the expected previous hop of the corresponding flow. If Route Maintenance cannot confirm the reachability of the previous hop, the node checks if the network interface requires bidirectional links for operation. If it does, the node silently discards the Route Error; otherwise, it sends the Error as if it were originating it, as described in Section 8.1.1.
- o On receiving a Route Error of type `UNKNOWN_FLOW` that this node is the Error Destination Address of, remove the Route Error from the packet and mark the flow specified by the triple (Error Destination Address, Original IP Destination Address, Flow ID) as not having been established end-to-end.
- o On receiving a Route Error of type `DEFAULT_FLOW_UNKNOWN` that this node is not the Error Destination Address of, the node checks if the Route Error corresponds to a flow in its Default Flow Table. If it does not, the node silently discards the Route Error; otherwise, it forwards the packet to the expected previous hop of the corresponding flow. If Route Maintenance cannot confirm the reachability of the previous hop, the node checks if the network interface requires bidirectional links for operation. If it does, the node silently discards the Route Error; otherwise, it sends the Error as if it were originating it, as described in Section 8.1.1.
- o On receiving a Route Error of type `DEFAULT_FLOW_UNKNOWN` that this node is the Error Destination Address of, remove the Route Error from the packet and mark the default flow between the Error Destination Address and the Original IP Destination Address as not having been established end-to-end.

- o On receiving an Acknowledgement Request option, the receiving node removes the Acknowledgement Request option and replies to the previous hop with an Acknowledgement option. If the previous hop cannot be determined, the Acknowledgement Request option is discarded, and processing continues.
- o On receiving an Acknowledgement option, the receiving node removes the Acknowledgement option and processes it.
- o On receiving any Acknowledgement option, add the appropriate link to the Route Cache, as specified in Section 8.1.4.
- o On receiving any Source Route option, add appropriate links to the Route Cache, as specified in Section 8.1.4.
- o On receiving a Source Route option, if no DSR Flow State header is present, if the flow this packet is being sent along is in the Flow Table, or if no Timeout option preceded the Source Route option in this DSR Options header, process it as specified in Section 8.1.4. Stop processing this packet unless the last address in the Source Route option is an address of this node.
- o On receiving a Source Route option in a packet with a DSR Flow State header, if the Flow ID specified in the DSR Flow State header is not in the Flow Table, add the flow to the Flow Table, setting the Timeout value to a value not greater than the Timeout field of the Timeout option in this header. If no Timeout option preceded the Source Route option in this header, the flow MUST NOT be added to the Flow Table.

If the Flow ID is odd and larger than any unexpired, odd Flow IDs for this (IP Source Address, IP Destination Address), it is set to be default in the Default Flow ID Table.

Then process the Route option as specified in Section 8.1.4. Stop processing this packet unless the last address in the Source Route option is an address of this node.

- o On receiving a Timeout option, check if this packet contains a DSR Flow State header. If this packet does not contain a DSR Flow State header, discard the DSR option. Otherwise, record the Timeout value in the option for future reference. The value recorded SHOULD be discarded when the node has finished processing this DSR Options header. If the flow that this packet is being sent along is in the Flow Table, it MAY set the flow to time out no more than Timeout seconds in the future.

- o On receiving a Destination and Flow ID option, if the IP Destination Address is not an address of this node, forward the packet according to the Flow ID, as described in Section 8.6.4, and stop processing this packet.
- o On receiving a Destination and Flow ID option, if the IP Destination Address is an address of this node, set the IP Destination Address to the New IP Destination Address specified in the option and set the Flow ID to the New Flow Identifier. Then remove the Destination and Flow ID option from the packet and continue processing.
- If the IP Destination Address is an address of this node, remove the DSR Options header, if any, pass the packet up the network stack, and stop processing.
- If there is still a DSR Options header containing no options, remove the DSR Options header.
- If there is still a DSR Flow State header, forward the packet according to the Flow ID, as described in Section 8.6.4.
- If there is neither a DSR Options header nor a DSR Flow State header, but there is an entry in the Default Flow Table for the (IP Source Address, IP Destination Address) pair:
 - o If the IP TTL is not equal to the TTL expected in the Flow Table, insert a DSR Flow State header, setting the Hop Count equal to the Hop Count of this node, and the Flow ID equal to the default Flow ID found in the Default Flow Table, and forward this packet according to the Flow ID, as described in Section 8.6.4.
 - o Otherwise, follow the steps for forwarding the packet using Flow IDs described in Section 8.6.4, but taking the Flow ID to be the default Flow ID found in the Default Flow Table.
- If there is no DSR Options header and no DSR Flow State header and no default flow can be found, the node returns a Route Error of type `DEFAULT_FLOW_UNKNOWN` to the IP Source Address, specifying the IP Destination Address as the Original IP Destination in the type-specific field.

8.6.4. Forwarding a Packet Using Flow IDs

To forward a packet using Flow IDs, a node MUST follow the following sequence of steps:

- If the triple (IP Source Address, IP Destination Address, Flow ID) is not in the Flow Table, return a Route Error of type UNKNOWN_FLOW.
- If a network-layer acknowledgement is required for Route Maintenance for the next hop, the node MUST include an Acknowledgement Request option as specified in Section 8.3.3. If no DSR Options header is in the packet in which the Acknowledgement Request option is to be added, it MUST be included, as described in Section 8.1.2, except that it MUST be added after the DSR Flow State header, if one is present.
- Attempt to transmit this packet to the next hop as specified in the Flow Table, performing Route Maintenance to detect broken routes.

8.6.5. Promiscuously Receiving a Packet

This section describes processing only for packets that have MAC destinations other than this processing node. Otherwise, the process described in Section 8.6.3 should be followed.

When a node using DSR flow state promiscuously overhears a packet, it SHOULD follow the following steps for processing:

- If the packet contains a DSR Flow State header, and if the triple (IP Source Address, IP Destination Address, Flow ID) is in the Flow Table and the Hop Count is less than the Hop Count in the flow's entry, the node MAY retain the packet in the Automatic Route Shortening Table. If it can be determined that this Flow ID has been recently used, the node SHOULD retain the packet in the Automatic Route Shortening Table.
- If the packet contains neither a DSR Flow State header nor a Source Route option and a Default Flow ID can be found in the Default Flow Table for the (IP Source Address, IP Destination Address), and if the IP TTL is greater than the TTL in the Flow Table for the default flow, the node MAY retain the packet in the Automatic Route Shortening Table. If it can be determined that this Flow ID has been used recently, the node SHOULD retain the packet in the Automatic Route Shortening Table.

8.6.6. Operation Where the Layer below DSR Decreases the IP TTL Non-uniformly

Some nodes may use an IP tunnel as a DSR hop. If different packets sent along this IP tunnel can take different routes, the reduction in IP TTL across this link may be different for different packets. This prevents the Automatic Route Shortening and Loop Detection functionality from working properly when used in conjunction with default routes.

Nodes forwarding packets without a Source Route option onto a link with unpredictable TTL changes MUST ensure that a DSR Flow State header is present, indicating the correct Hop Count and Flow ID.

8.6.7. Salvage Interactions with DSR

Nodes salvaging packets MUST remove the DSR Flow State header, if present.

Anytime this document refers to the Salvage field in the Source Route option, packets without a Source Route option are considered to have the value zero in the Salvage field.

9. Protocol Constants and Configuration Variables

Any DSR implementation MUST support the following configuration variables and MUST support a mechanism enabling the value of these variables to be modified by system management. The specific variable names are used for demonstration purposes only, and an implementation is not required to use these names for the configuration variables, so long as the external behavior of the implementation is consistent with that described in this document.

For each configuration variable below, the default value is specified to simplify configuration. In particular, the default values given below are chosen for a DSR network running over 2 Mbps IEEE 802.11 network interfaces using the Distributed Coordination Function (DCF) MAC protocol with RTS and CTS [IEEE80211, BROCH98].

DiscoveryHopLimit	255	hops
BroadcastJitter	10	milliseconds
RouteCacheTimeout	300	seconds
SendBufferTimeout	30	seconds
RequestTableSize	64	nodes
RequestTableIds	16	identifiers
MaxRequestRexmt	16	retransmissions
MaxRequestPeriod	10	seconds
RequestPeriod	500	milliseconds
NonpropRequestTimeout	30	milliseconds
RexmtBufferSize	50	packets
MaintHoldoffTime	250	milliseconds
MaxMaintRexmt	2	retransmissions
TryPassiveAcks	1	attempt
PassiveAckTimeout	100	milliseconds
GratReplyHoldoff	1	second

In addition, the following protocol constant MUST be supported by any implementation of the DSR protocol:

MAX_SALVAGE_COUNT	15	salvages
-------------------	----	----------

10. IANA Considerations

This document specifies the DSR Options header and DSR Flow State header, for which the IP protocol number 48 has been assigned. A single IP protocol number can be used for both header types, since they can be distinguished by the Flow State Header (F) bit in each header.

In addition, this document proposes use of the value "No Next Header" (originally defined for use in IPv6 [RFC2460]) within an IPv4 packet, to indicate that no further header follows a DSR Options header.

Finally, this document introduces a number of DSR options for use in the DSR Options header, and additional new DSR options may be defined in the future. Each of these options requires a unique Option Type value, the most significant 3 bits (that is, Option Type & 0xE0) encoded as defined in Section 6.1. It is necessary only that each Option Type value be unique, not that they be unique in the remaining 5 bits of the value after these 3 most significant bits.

Two registries (DSR Protocol Options and DSR Protocol Route Error Types) have been created and contain the initial registrations. Assignment of new values for DSR options will be by Expert Review [RFC2434], with the authors of this document serving as the Designated Experts.

11. Security Considerations

This document does not specifically address security concerns. This document does assume that all nodes participating in the DSR protocol do so in good faith and without malicious intent to corrupt the routing ability of the network.

Depending on the threat model, a number of different mechanisms can be used to secure DSR. For example, in an environment where node compromise is unrealistic and where all the nodes participating in the DSR protocol share a common goal that motivates their participation in the protocol, the communications between the nodes can be encrypted at the physical channel or link layer to prevent attack by outsiders. Cryptographic approaches, such as that provided by Ariadne [HU02] or Secure Routing Protocol (SRP) [PAPADIMITRATOS02], can resist stronger attacks.

Appendix A. Link-MaxLife Cache Description

As guidance to implementers of DSR, the description below outlines the operation of a possible implementation of a Route Cache for DSR that has been shown to outperform other caches studied in detailed simulations. Use of this design for the Route Cache is recommended in implementations of DSR.

This cache, called "Link-MaxLife" [HU00], is a link cache, in that each individual link (hop) in the routes returned in Route Reply packets (or otherwise learned from the header of overhead packets) is added to a unified graph data structure of this node's current view of the network topology, as described in Section 4.1. To search for a route in this cache to some destination node, the sending node uses a graph search algorithm, such as the well-known Dijkstra's shortest-path algorithm, to find the current best path through the graph to the destination node.

The Link-MaxLife form of link cache is adaptive in that each link in the cache has a timeout that is determined dynamically by the caching node according to its observed past behavior of the two nodes at the ends of the link; in addition, when selecting a route for a packet being sent to some destination, among cached routes of equal length (number of hops) to that destination, Link-MaxLife selects the route with the longest expected lifetime (highest minimum timeout of any link in the route).

Specifically, in Link-MaxLife, a link's timeout in the Route Cache is chosen according to a "Stability Table" maintained by the caching node. Each entry in a node's Stability Table records the address of another node and a factor representing the perceived "stability" of this node. The stability of each other node in a node's Stability Table is initialized to `InitStability`. When a link from the Route Cache is used in routing a packet originated or salvaged by that node, the stability metric for each of the two endpoint nodes of that link is incremented by the amount of time since that link was last used, multiplied by `StabilityIncrFactor` (`StabilityIncrFactor` ≥ 1); when a link is observed to break and the link is thus removed from the Route Cache, the stability metric for each of the two endpoint nodes of that link is multiplied by `StabilityDecrFactor` (`StabilityDecrFactor` < 1).

When a node adds a new link to its Route Cache, the node assigns a lifetime for that link in the Cache equal to the stability of the less "stable" of the two endpoint nodes for the link, except that a link is not allowed to be given a lifetime less than `MinLifetime`. When a link is used in a route chosen for a packet originated or salvaged by this node, the link's lifetime is set to be at least

UseExtends into the future; if the lifetime of that link in the Route Cache is already further into the future, the lifetime remains unchanged.

When a node using Link-MaxLife selects a route from its Route Cache for a packet being originated or salvaged by this node, it selects the shortest-length route that has the longest expected lifetime (highest minimum timeout of any link in the route), as opposed to simply selecting an arbitrary route of shortest length.

The following configuration variables are used in the description of Link-MaxLife above. The specific variable names are used for demonstration purposes only, and an implementation is not required to use these names for these configuration variables. For each configuration variable below, the default value is specified to simplify configuration. In particular, the default values given below are chosen for a DSR network where nodes move at relative velocities between 12 and 25 seconds per wireless transmission radius.

InitStability	25	seconds
StabilityIncrFactor	4	
StabilityDecrFactor	0.5	
MinLifetime	1	second
UseExtends	120	seconds

Appendix B. Location of DSR in the ISO Network Reference Model

When designing DSR, we had to determine at what layer within the protocol hierarchy to implement ad hoc network routing. We considered two different options: routing at the link layer (ISO layer 2) and routing at the network layer (ISO layer 3). Originally, we opted to route at the link layer for several reasons:

- Pragmatically, running the DSR protocol at the link layer maximizes the number of mobile nodes that can participate in ad hoc networks. For example, the protocol can route equally well between IPv4 [RFC791], IPv6 [RFC2460], and IPX [TURNER90] nodes.
- Historically [JOHNSON94, JOHNSON96a], DSR grew from our contemplation of a multi-hop propagating version of the Internet's Address Resolution Protocol (ARP) [RFC826], as well as from the routing mechanism used in IEEE 802 source routing bridges [PERLMAN92]. These are layer 2 protocols.
- Technically, we designed DSR to be simple enough that it could be implemented directly in the firmware inside wireless network interface cards [JOHNSON94, JOHNSON96a], well below the layer 3 software within a mobile node. We see great potential in this for DSR running inside a cloud of mobile nodes around a fixed base station, where DSR would act to transparently extend the coverage range to these nodes. Mobile nodes that would otherwise be unable to communicate with the base station due to factors such as distance, fading, or local interference sources could then reach the base station through their peers.

Ultimately, however, we decided to specify and to implement [MALTZ99b] DSR as a layer 3 protocol, since this is the only layer at which we could realistically support nodes with multiple network interfaces of different types forming an ad hoc network.

Appendix C. Implementation and Evaluation Status

The initial design of the DSR protocol, including DSR's basic Route Discovery and Route Maintenance mechanisms, was first published in December 1994 [JOHNSON94]; significant additional design details and initial simulation results were published in early 1996 [JOHNSON96a].

The DSR protocol has been extensively studied since then through additional detailed simulations. In particular, we have implemented DSR in the ns-2 network simulator [NS-2, BROCH98] and performed extensive simulations of DSR using ns-2 (e.g., [BROCH98, MALTZ99a]). We have also conducted evaluations of the different caching strategies in this document [HU00].

We have also implemented the DSR protocol under the FreeBSD 2.2.7 operating system running on Intel x86 platforms. FreeBSD [FREEBSD] is based on a variety of free software, including 4.4 BSD Lite, from the University of California, Berkeley. For the environments in which we used it, this implementation is functionally equivalent to the version of the DSR protocol specified in this document.

During the 7 months from August 1998 to February 1999, we designed and implemented a full-scale physical testbed to enable the evaluation of ad hoc network performance in the field, in an actively mobile ad hoc network under realistic communication workloads. The last week of February and the first week of March of 1999 included demonstrations of this testbed to a number of our sponsors and partners, including Lucent Technologies, Bell Atlantic, and the Defense Advanced Research Projects Agency (DARPA). A complete description of the testbed is available [MALTZ99b, MALTZ00, MALTZ01].

We have since ported this implementation of DSR to FreeBSD 3.3, and we have also added a preliminary version of Quality of Service (QoS) support for DSR. A demonstration of this modified version of DSR was presented in July 2000. These QoS features are not included in this document and will be added later in a separate document on top of the base protocol specified here.

DSR has also been implemented under Linux by Alex Song at the University of Queensland, Australia [SONG01]. This implementation supports the Intel x86 PC platform and the Compaq iPAQ.

The Network and Telecommunications Research Group at Trinity College, Dublin, have implemented a version of DSR on Windows CE.

Microsoft Research has implemented a version of DSR on Windows XP and has used it in testbeds of over 15 nodes. Several machines use this implementation as their primary means of accessing the Internet.

Several other independent groups have also used DSR as a platform for their own research, or as a basis of comparison between ad hoc network routing protocols.

A preliminary version of the optional DSR flow state extension was implemented in FreeBSD 3.3. A demonstration of this modified version of DSR was presented in July 2000. The DSR flow state extension has also been extensively evaluated using simulation [HU01].

Acknowledgements

The protocol described in this document has been designed and developed within the Monarch Project, a long-term research project at Rice University (previously at Carnegie Mellon University) that is developing adaptive networking protocols and protocol interfaces to allow truly seamless wireless and mobile node networking [JOHNSON96b, MONARCH].

The authors would like to acknowledge the substantial contributions of Josh Broch in helping to design, simulate, and implement the DSR protocol. We thank him for his contributions to earlier versions of this document.

We would also like to acknowledge the assistance of Robert V. Barron at Carnegie Mellon University. Bob ported our DSR implementation from FreeBSD 2.2.7 into FreeBSD 3.3.

Many valuable suggestions came from participants in the IETF process. We would particularly like to acknowledge Fred Baker, who provided extensive feedback on a previous version of this document, as well as the working group chairs, for their suggestions of previous versions of the document.

Normative References

- [RFC791] Postel, J., "Internet Protocol", STD 5, RFC 791, September 1981.
- [RFC792] Postel, J., "Internet Control Message Protocol", STD 5, RFC 792, September 1981.
- [RFC826] Plummer, David C., "Ethernet Address Resolution Protocol: Or converting network protocol addresses to 48.bit Ethernet address for transmission on Ethernet hardware", STD 37, RFC 826, November 1982.
- [RFC1122] Braden, R., "Requirements for Internet Hosts - Communication Layers", STD 3, RFC 1122, October 1989.
- [RFC1700] Reynolds, J. and J. Postel, "Assigned Numbers", STD 2, RFC 1700, October 1994. See also <http://www.iana.org/numbers.html>.
- [RFC2003] Perkins, C., "IP Encapsulation within IP", RFC 2003, October 1996. RFC 2003, October 1996.
- [RFC2119] Bradner, S., "Key words for use in RFCs to Indicate Requirement Levels", BCP 14, RFC 2119, March 1997.
- [RFC2434] Narten, T. and H. Alvestrand, "Guidelines for Writing an IANA Considerations Section in RFCs", BCP 26, RFC 2434, October 1998.

Informative References

- [BANTZ94] David F. Bantz and Frederic J. Bauchot. Wireless LAN Design Alternatives. IEEE Network, 8(2):43-53, March/April 1994.
- [BHARGHAVAN94] Vaduvur Bharghavan, Alan Demers, Scott Shenker, and Lixia Zhang. MACAW: A Media Access Protocol for Wireless LAN's. In Proceedings of the ACM SIGCOMM '94 Conference, pages 212-225. ACM, August 1994.
- [BROCH98] Josh Broch, David A. Maltz, David B. Johnson, Yih-Chun Hu, and Jorjeta Jetcheva. A Performance Comparison of Multi-Hop Wireless Ad Hoc Network Routing Protocols. In Proceedings of the Fourth Annual ACM/IEEE International Conference on Mobile Computing and Networking, pages 85-97. ACM/IEEE, October 1998.

- [CLARK88] David D. Clark. The Design Philosophy of the DARPA Internet Protocols. In Proceedings of the ACM SIGCOMM '88 Conference, pages 106-114. ACM, August 1988.
- [FREEBSD] The FreeBSD Project. Project web page available at <http://www.freebsd.org/>.
- [HU00] Yih-Chun Hu and David B. Johnson. Caching Strategies in On-Demand Routing Protocols for Wireless Ad Hoc Networks. In Proceedings of the Sixth Annual ACM International Conference on Mobile Computing and Networking. ACM, August 2000.
- [HU01] Yih-Chun Hu and David B. Johnson. Implicit Source Routing in On-Demand Ad Hoc Network Routing. In Proceedings of the Second Symposium on Mobile Ad Hoc Networking and Computing (MobiHoc 2001), pages 1-10, October 2001.
- [HU02] Yih-Chun Hu, Adrian Perrig, and David B. Johnson. Ariadne: A Secure On-Demand Routing Protocol for Ad Hoc Networks. In Proceedings of the Eighth Annual International Conference on Mobile Computing and Networking (MobiCom 2002), pages 12-23, September 2002.
- [IEEE80211] IEEE Computer Society LAN MAN Standards Committee. Wireless LAN Medium Access Control (MAC) and Physical Layer (PHY) Specifications, IEEE Std 802.11-1997. The Institute of Electrical and Electronics Engineers, New York, New York, 1997.
- [JOHANSSON99] Per Johansson, Tony Larsson, Nicklas Hedman, Bartosz Mielczarek, and Mikael Degermark. Scenario-based Performance Analysis of Routing Protocols for Mobile Ad-hoc Networks. In Proceedings of the Fifth Annual ACM/IEEE International Conference on Mobile Computing and Networking, pages 195-206. ACM/IEEE, August 1999.
- [JOHNSON94] David B. Johnson. Routing in Ad Hoc Networks of Mobile Hosts. In Proceedings of the IEEE Workshop on Mobile Computing Systems and Applications, pages 158-163. IEEE Computer Society, December 1994.

- [JOHNSON96a] David B. Johnson and David A. Maltz. Dynamic Source Routing in Ad Hoc Wireless Networks. In *Mobile Computing*, edited by Tomasz Imielinski and Hank Korth, chapter 5, pages 153-181. Kluwer Academic Publishers, 1996.
- [JOHNSON96b] David B. Johnson and David A. Maltz. Protocols for Adaptive Wireless and Mobile Networking. *IEEE Personal Communications*, 3(1):34-42, February 1996.
- [JUBIN87] John Jubin and Janet D. Tornow. The DARPA Packet Radio Network Protocols. *Proceedings of the IEEE*, 75(1):21-32, January 1987.
- [KARN90] Phil Karn. MACA---A New Channel Access Method for Packet Radio. In *ARRL/CRRL Amateur Radio 9th Computer Networking Conference*, pages 134-140. American Radio Relay League, September 1990.
- [LAUER95] Gregory S. Lauer. Packet-Radio Routing. In *Routing in Communications Networks*, edited by Martha E. Steenstrup, chapter 11, pages 351-396. Prentice-Hall, Englewood Cliffs, New Jersey, 1995.
- [MALTZ99a] David A. Maltz, Josh Broch, Jorjeta Jetcheva, and David B. Johnson. The Effects of On-Demand Behavior in Routing Protocols for Multi-Hop Wireless Ad Hoc Networks. *IEEE Journal on Selected Areas of Communications*, 17(8):1439-1453, August 1999.
- [MALTZ99b] David A. Maltz, Josh Broch, and David B. Johnson. Experiences Designing and Building a Multi-Hop Wireless Ad Hoc Network Testbed. Technical Report CMU-CS-99-116, School of Computer Science, Carnegie Mellon University, Pittsburgh, Pennsylvania, March 1999.
- [MALTZ00] David A. Maltz, Josh Broch, and David B. Johnson. Quantitative Lessons From a Full-Scale Multi-Hop Wireless Ad Hoc Network Testbed. In *Proceedings of the IEEE Wireless Communications and Networking Conference*. IEEE, September 2000.
- [MALTZ01] David A. Maltz, Josh Broch, and David B. Johnson. Lessons From a Full-Scale MultiHop Wireless Ad Hoc Network Testbed. *IEEE Personal Communications*, 8(1):8-15, February 2001.

- [MONARCH] Rice University Monarch Project. Monarch Project Home Page. Available at <http://www.monarch.cs.rice.edu/>.
- [NS-2] The Network Simulator -- ns-2. Project web page available at <http://www.isi.edu/nsnam/ns/>.
- [PAPADIMITRATOS02] Panagiotis Papadimitratos and Zygmunt J. Haas. Secure Routing for Mobile Ad Hoc Networks. In SCS Communication Networks and Distributed Systems Modeling and Simulation Conference (CNDS 2002), January 2002.
- [PERLMAN92] Radia Perlman. Interconnections: Bridges and Routers. Addison-Wesley, Reading, Massachusetts, 1992.
- [RFC793] Postel, J., "Transmission Control Protocol", STD 7, RFC 793, September 1981.
- [RFC2131] Droms, R., "Dynamic Host Configuration Protocol", RFC 2131, March 1997.
- [RFC2460] Deering, S. and R. Hinden, "Internet Protocol, Version 6 (IPv6) Specification", RFC 2460, December 1998.
- [SONG01] Alex Song. picoNet II: A Wireless Ad Hoc Network for Mobile Handheld Devices. Submitted for the degree of Bachelor of Engineering (Honours) in the division of Electrical Engineering, Department of Information Technology and Electrical Engineering, University of Queensland, Australia, October 2001. Available at <http://piconet.sourceforge.net/thesis/index.html>.
- [TURNER90] Paul Turner. NetWare Communications Processes. NetWare Application Notes, Novell Research, pages 25-91, September 1990.
- [WRIGHT95] Gary R. Wright and W. Richard Stevens. TCP/IP Illustrated, Volume 2: The Implementation. Addison-Wesley, Reading, Massachusetts, 1995.

Authors' Addresses

David B. Johnson
Rice University
Computer Science Department, MS 132
6100 Main Street
Houston, TX 77005-1892
USA

Phone: +1 713 348-3063
Fax: +1 713 348-5930
EMail: dbj@cs.rice.edu

David A. Maltz
Microsoft Research
One Microsoft Way
Redmond, WA 98052
USA

Phone: +1 425 706-7785
Fax: +1 425 936-7329
EMail: dmaltz@microsoft.com

Yih-Chun Hu
University of Illinois at Urbana-Champaign
Coordinated Science Lab
1308 West Main St, MC 228
Urbana, IL 61801
USA

Phone: +1 217 333-4220
EMail: yihchun@uiuc.edu

Full Copyright Statement

Copyright (C) The IETF Trust (2007).

This document is subject to the rights, licenses and restrictions contained in BCP 78, and except as set forth therein, the authors retain all their rights.

This document and the information contained herein are provided on an "AS IS" basis and THE CONTRIBUTOR, THE ORGANIZATION HE/SHE REPRESENTS OR IS SPONSORED BY (IF ANY), THE INTERNET SOCIETY, THE IETF TRUST AND THE INTERNET ENGINEERING TASK FORCE DISCLAIM ALL WARRANTIES, EXPRESS OR IMPLIED, INCLUDING BUT NOT LIMITED TO ANY WARRANTY THAT THE USE OF THE INFORMATION HEREIN WILL NOT INFRINGE ANY RIGHTS OR ANY IMPLIED WARRANTIES OF MERCHANTABILITY OR FITNESS FOR A PARTICULAR PURPOSE.

Intellectual Property

The IETF takes no position regarding the validity or scope of any Intellectual Property Rights or other rights that might be claimed to pertain to the implementation or use of the technology described in this document or the extent to which any license under such rights might or might not be available; nor does it represent that it has made any independent effort to identify any such rights. Information on the procedures with respect to rights in RFC documents can be found in BCP 78 and BCP 79.

Copies of IPR disclosures made to the IETF Secretariat and any assurances of licenses to be made available, or the result of an attempt made to obtain a general license or permission for the use of such proprietary rights by implementers or users of this specification can be obtained from the IETF on-line IPR repository at <http://www.ietf.org/ipr>.

The IETF invites any interested party to bring to its attention any copyrights, patents or patent applications, or other proprietary rights that may cover technology that may be required to implement this standard. Please address the information to the IETF at ietf-ipr@ietf.org.

Acknowledgement

Funding for the RFC Editor function is currently provided by the Internet Society.

